



DIESSA

www.diessa.es

Excellence beyond quality



IVECO CATALOGUE

| model | page |
|-------------------------------------|------|
| IV EUROSTAR 440 | 05 |
| IV EUROSTAR 240 | 09 |
| IV EUROTECH | 13 |
| IV EUROTRAKKER | 17 |
| IV EUROCARGO 60 | 21 |
| IV EUROCARGO 120 | 25 |
| IV EUROCARGO 150 | 29 |
| IV STRALIS AS | 33 |
| IV STRALIS AD/AT | 41 |
| IV TECTOR RESTYLING 75 | 47 |
| IV TECTOR RESTYLING 125 | 49 |
| IV TECTOR RESTYLING 155 | 53 |
| IV TECTOR RESTYLING 185 | 57 |
| IV STRALIS AS 2008-> | 61 |
| IV STRALIS AD/AT 2008-> | 67 |
| IV EUROCARGO 2008 | 73 |
| IV AD/AT STRALIS 2013 HI-ROAD_EURO6 | 76 |
| IV AS STRALIS 2013 HI-WAY_EURO | 83 |
| IV EUROCARGO 2015 | 88 |

IV EUROSTAR 440



DC0.2132



DC0.1820



D0600063



DC0.0990



DC0.0991

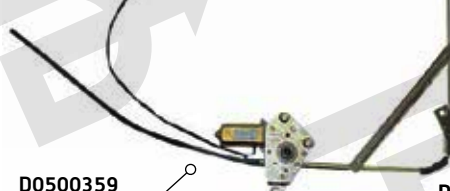

D0500359



DC0.0900



DC0.0894



DC0.0995



DC0.0896



DC0.0895



DC0.0897



DC0.1054

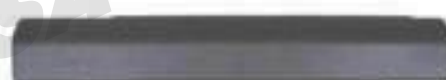

DC0.1049



DC0.1050



D0700069



DC0.1051



DC0.1055

The parts referenced in this catalog are not original, but are perfectly adaptable to the models to which they are intended. The use of the manufacturers' marks and the original references is done exclusively for the purpose of indicating the model to which each piece is destined.

IV EUROSTAR 440

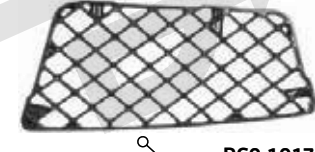
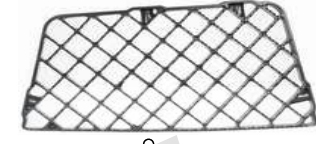
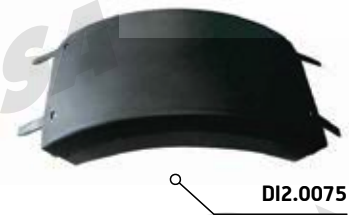

The parts referenced in this catalog are not original, but are perfectly adaptable to the models to which they are intended. The use of the manufacturers' marks and the original references is done exclusively for the purpose of indicating the model to which each piece is destined.

IV EUROSTAR 440



The parts referenced in this catalog are not original, but are perfectly adaptable to the models to which they are intended.
The use of the manufacturers' marks and the original references is done exclusively for the purpose of indicating the model to which each piece is destined.

| DIESSA REF. | O.E.M. REF. | DESCRIPTION |
|-------------|------------------------------|-------------------------------------------------|
| DCO.0900 | 8143891,504111690 | FRONT GRILLE |
| DCO.0896 | 98405557,99805627,500389854 | CORNER BUMPER, RH |
| DCO.0897 | 98405555,99805628,500389853 | CORNER BUMPER, LH |
| DCO.0894 | 98438450 | BUMPER W/FOG LAMP HOLE |
| DCO.0895 | 98419670,/2997105 | BUMPER W/O FOG LAMP HOLE |
| DCO.1049 | 8143003,98499858 | CENTRAL PLATE |
| DCO.1050 | 8143032 | FR LICENSE PLATE HOLDER |
| D0700069 | 98473849 | COVER BUMPER. DARK GREY |
| DCO.1051 | 8143223,3798588 | STEP ON BUMPER |
| DCO.1054 | 98405560 | SIDE SUPPORT, RH |
| DCO.1055 | 98405561 | SIDE SUPPORT, LH |
| DI2.0681 | 41210252,41210253,41210254 | REAR HALF MUDGUARD RH/LH FRONT AND REAR SECTION |
| DCO.1072 | 41032399,2997165 | TOP MUDGUARD W/O STRAPE |
| DCO.1040 | 41003236 | REAR MUDGUARD UPPER RH |
| DCO.1041 | 41002927,42125604 | REAR MUDGUARD UPPER LH |
| DCO.1510 | 41032400,2997166 | TOP MUDGUARD W/O STRAPE |
| D0500134 | 42559051,42533556,5001842757 | RUBER STRAPE |
| DI2.0076 | 41032401,2997167 | REAR MUDGUARD RH=LH |
| D0600171 | 8144468,8144470,814446800 | REAR MUDGUARD LH |
| D0600172 | 8144469 | REAR MUDGUARD RH |
| DI2.0075 | 41032402,2997168 | REAR MUDGUARD CENTRE CURVING TYPE |
| DCO.1052 | 99805623,98438466,99805623 | FOOTBOARD RH |
| DCO.1053 | 99805624,98438467,2997319 | FOOTBOARD LH |
| D0700240 | 8144393,98442028 | FOOTSTEP RH |
| D0700241 | 8144394,98442029 | FOOTSTEP LH |
| DCO.1047 | 3798587/8143222 | BUMPER GRILLE RH=LH ALUMINIUM |
| DCO.1002 | 8142607,3798586 | STEP PANEL |
| DCO.1017 | 3798585,8142610 | STEP PANEL, UPPER (RH=LH) |
| DCO.1018 | 3798584,8142611 | STEP PANEL, LOWER (RH=LH) |
| D0600174 | 98474429 | BATTERY COVER |
| DCO.2132 | 500335296 | OUTSIDE HANDLE SET, 2 CYLS + 4KEYS |
| DCO.0990 | 98404709,98404713 | OUTSIDE HANDLE W/KEY RH (1 CYLINDER 2 KEYS) |
| DCO.0991 | 98404710,98404714 | OUTSIDE HANDLE W/KEY LH (1 CYLINDER 2 KEYS) |

| DIESSA REF. | O.E.M. REF. | DESCRIPTION |
|-------------|-----------------------------------------------|-----------------------------------------------------------|
| DCO.1820 | 98472613,98407510 | INSIDE HANDLE, FRONT RH=LH |
| D0600063 | 2992664 | KEY CYLINDER (1 CYLINDER 2 KEYS) |
| D0500359 | 99487780,2997195 | ELECTRICAL WINDOW REGULATOR RH W/O MOTOR |
| DCO.0995 | 99487781,2997196 | ELECTRICAL WINDOW REGULATOR RH W/O MOTOR |
| D0600005 | 4861793 | HEAD LAMP RH MANUAL/ELECTRIC H4/H3/T4W |
| D0600006 | 4861794 | HEAD LAMP LH MANUAL/ELECTRIC H4/H3/T4W |
| D0600001 | 98437475 | FOG LAMP RH H3/H3 |
| D0600002 | 98437476 | FOG LAMP LH H3/H3 |
| D0500478 | 504094705,99463242 | TAIL LAMP RH 3 R5W 4 P21W |
| D0500477 | 504094715,99463244 | TAIL LAMP LH 3 R5W 4 P21W |
| D0500294 | 98449181 | CORNER LAMP RH |
| D0500297 | 98449182 | CORNER LAMP LH |
| DC2.3149 | 504001931 | REFLECTOR |
| DI2.0894 | 98472983 | MAIN MIRROR RH CLASS II ELECTRIC HEATED R1200 LHD |
| D0700066 | 98472979,98473007 | MAIN MIRROR LH CLASS II ELECTRIC HEATED R1200 LHD |
| DI2.0893 | 98472982 | MAIN MIRROR RH CLASS II MANUAL HEATED R1200 LHD |
| DI2.0848 | 98472977 | MAIN MIRROR LH CLASS II MANUAL HEATED R1200 LHD |
| DI2.0753 | 2996671,504132249 | WIDE ANGLE MIRROR RH=LH CLASS IV ELECTRIC HEATED R300 LHD |
| DI2.0752 | 2996670,504132248 | WIDE ANGLE MIRROR RH=LH CLASS IV MANUAL HEATED R300 LHD |
| D0500446 | 42548403,93193199,2997253 | MIRROR GLASS CLASS IV WIDE ANGLE RH=LH HEATED R300 LHD |
| D0500448 | 93190970 | MIRROR GLASS CLASS II RH=LH HEATED R1200 LHD |
| D0500447 | 93190976 | MIRROR GLASS CLASS II RH=LH HEATED R1200 LHD |
| DIO.0002 | 504132244,98409111,98472975,98409260,98473002 | MIRROR ROOF CLASS V RH ELECTRIC HEATED R300 LHD |
| DI2.0897 | 504132243,98472974,98409110 | MIRROR ROOF CLASS V RH MANUAL HEATED R300 LHD |



DC0.1072



DC0.1510



DI2.0076



DC0.0900



DC0.0899



DI2.0075



DI2.0681



X2

X2



DC0.1049



DC0.1050



D0700069



DC0.1051



D0500134

The parts referenced in this catalog are not original, but are perfectly adaptable to the models to which they are intended. The use of the manufacturers' marks and the original references is done exclusively for the purpose of indicating the model to which each piece is destined.



DCO.2132



DCO.0990

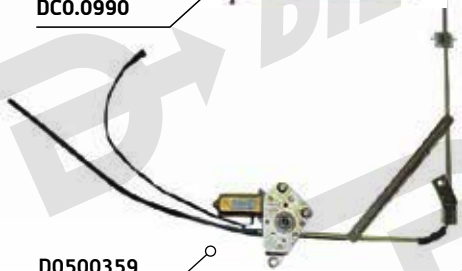

D0500359

DCO.1047



DCO.1017



DCO.1820



D0600063



DCO.0991

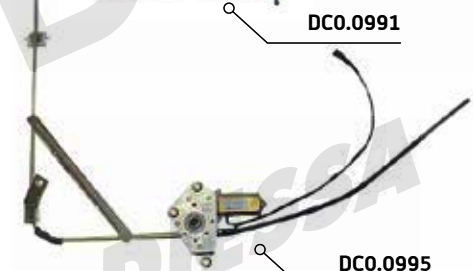

DCO.0995



DCO.1052



DCO.1032



DCO.1002

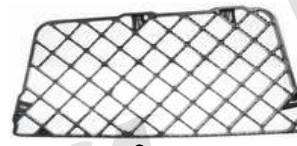

DCO.1018



DCO.1033



DCO.1053



D0700240



DCO.1030



DCO.1031



D0700241

The parts referenced in this catalog are not original, but are perfectly adaptable to the models to which they are intended. The use of the manufacturers' marks and the original references is done exclusively for the purpose of indicating the model to which each piece is destined.

IV EUROSTAR 240



DI2.0894

DI2.0893



DI2.0753
DI2.0752



DI0.0002
DI2.0897



D0500295



D0600005



D0600006



D0600001



D0600002



D0500296



D0500446



DI2.0891

DI2.0848



D0500448
D0500447



D0500478

DC2.3149



D0500477

The parts referenced in this catalog are not original, but are perfectly adaptable to the models to which they are intended. The use of the manufacturers' marks and the original references is done exclusively for the purpose of indicating the model to which each piece is destined.

| DIESSA REF. | O.E.M. REF. | DESCRIPTION |
|-------------|--------------------------------|-------------------------------------------------|
| DC0.0900 | 8143891, 504111690 | FRONT GRILLE |
| DC0.0899 | 98438449, 2997104 | BUMPER W/O FOG LAMP HOLE |
| DC0.1051 | 8143223, 3798588 | STEP ON BUMPER |
| DC0.1049 | 8143003, 98499858 | CENTRAL PLATE |
| DC0.1050 | 8143032 | FR LICENSE PLATE HOLDER |
| D0700069 | 98473849 | COVER BUMPER. DARK GREY |
| DI2.0681 | 41210252, 41210253, 41210254 | REAR HALF MUDGUARD RH/LH FRONT AND REAR SECTION |
| DC0.1072 | 41032399, 2997165, tech | TOP MUDGUARD W/O STRAPE |
| DC0.1510 | 41032400, 2997166 | TOP MUDGUARD W/O STRAPE |
| D0500134 | 42559051, 42533556, 5001842757 | RUBER STRAPE |
| DI2.0076 | 41032401, 2997167 | REAR MUDGUARD RH=LH |
| DI2.0075 | 41032402, 2997168 | REAR MUDGUARD CENTRE CURVING TYPE |
| DC0.1052 | 99805623, 98438466, 99805623 | FOOTBOARD RH |
| DC0.1053 | 99805624, 98438467, 2997319 | FOOTBOARD LH |
| DC0.1030 | 8144329 | FR MUDGUARD, RH |
| DC0.1031 | 8144328, 8144328 | FR MUDGUARD, LH |
| D0700240 | 8144393, 98442028 | FOOTSTEP RH |
| D0700241 | 8144394, 98442029 | FOOTSTEP LH |
| DC0.1032 | 99805621, 2997316, 98417357 | FOOTBOARD, RH |
| DC0.1033 | 99805622, 98417358, 2997317 | FOOTBOARD, LH |
| DC0.1047 | 3798587, 8143222 | BUMPER GRILLE RH=LH ALUMINIUM |
| DC0.1002 | 8142607, 3798586 | STEP PANEL |
| DI2.0865 | 3798585, 8142610, 3798583 | STEP PANEL, UPPER (R=L) |
| DC0.1018 | 3798584, 8142611 | STEP PANEL, LOWER (R=L) |
| DC0.2132 | 500335296 | OUTSIDE HANDLE SET, 2 CYLS + 4 KEYS |
| DC0.0990 | 98404709 WK, 98404713 | OUTSIDE HANDLE W/KEY RH (1 CYLINDER 2 KEYS) |
| DC0.0991 | 98404710, 98404714 | OUTSIDE HANDLE W/KEY LH (1 CYLINDER 2 KEYS) |
| DC0.1820 | 98472613, 98407510 | INSIDE HANDLE, FRONT RH=LH |
| D0500359 | 99487780, 2997195 | ELECTRICAL WINDOW REGULATOR RH W/O MOTOR |
| DC0.0995 | 99487781, 2997196 | ELECTRICAL WINDOW REGULATOR RH W/O MOTOR |

| DIESSA REF. | O.E.M. REF. | DESCRIPTION |
|-------------|---------------------------------------------------|--------------------------------------------------------------------|
| D0600005 | 4861793 | HEAD LAMP RH MANUAL/ELECTRIC H4/H3/T4W |
| D0600006 | 4861794 | HEAD LAMP LH MANUAL/ELECTRIC H4/H3/T4W |
| D0600001 | 98437475 | FOG LAMP RH H3/H3 |
| D0600002 | 98437476 | FOG LAMP LH H3/H3 |
| D0500478 | 99463242, 99463242, 504094705 | TAIL LAMP RH W/O LICENSE LAMP R5W/P21W/P21W/R5W/R5W/P21W/P21W/R10W |
| D0500477 | 99463244, 99463244, 504094715 | TAIL LAMP LH W/O LICENSE LAMP R5W/P21W/P21W/R5W/R5W/P21W/P21W/R10W |
| D0500295 | 98460036 | CORNER HEAD LAMP RH P21W |
| D0500296 | 98460038 | CORNER HEAD LAMP LH P21W |
| DC2.3149 | 504001931 | REFLECTOR |
| DI2.0894 | 98472983 | MAIN MIRROR RH CLASS II ELECTRIC HEATED R1200 LHD |
| DI2.0891 | 98472979, 98473007 | MAIN MIRROR LH CLASS II ELECTRIC HEATED R1200 LHD |
| DI2.0893 | 98472982 | MAIN MIRROR RH CLASS II MANUAL HEATED R1200 LHD |
| DI2.0848 | 98472977 | MAIN MIRROR LH CLASS II MANUAL HEATED R1200 LHD |
| DI2.0753 | 2996671, 504132249 | WIDE ANGLE MIRROR RH=LH CLASS IV ELECTRIC HEATED R300 LHD |
| DI2.0752 | 2996670, 504132248 | WIDE ANGLE MIRROR RH=LH CLASS IV MANUAL HEATED R300 LHD |
| D0500446 | 42548403, 93193199, 2997253 | MIRROR GLASS CLASS IV WIDE ANGLE RH=LH HEATED R300 LHD |
| D0500448 | 93190970 | MIRROR GLASS CLASS II RH=LH HEATED R1200 LHD |
| D0500447 | 93190976 | MIRROR GLASS CLASS II RH=LH HEATED R1200 LHD |
| DI0.0002 | 504132244, 98409111, 98472975, 98409260, 98473002 | MIRROR ROOF CLASS V RH ELECTRIC HEATED R300 LHD |



DCO.1072



DI2.0076



DCO.1510



DI2.0075



D0600172



DCO.0900



DCO.0899



D0600171



DCO.1040



DCO.1049



DCO.1050



DCO.1041



DI2.0681



X 2

X 2

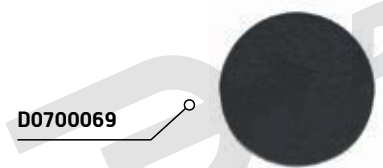

D0700069



DCO.1051



D0500134

The parts referenced in this catalog are not original, but are perfectly adaptable to the models to which they are intended. The use of the manufacturers' marks and the original references is done exclusively for the purpose of indicating the model to which each piece is destined.



DCO.2132



DCO.0990

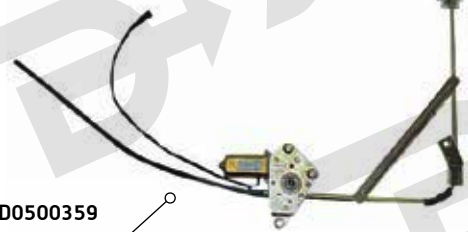

D0500359



DCO.1047



D0600174



DCO.1017



DCO.1820



D0600063



DCO.0991

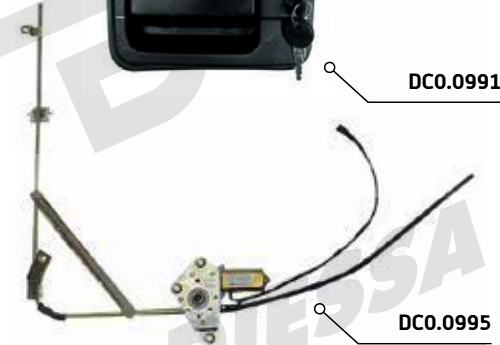

DCO.0995



DCO.1052



DCO.1032

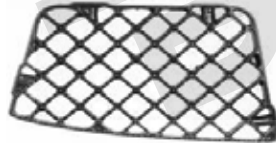

DCO.1002

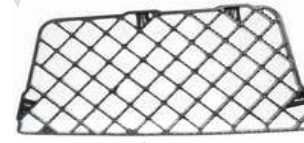

DCO.1018



DCO.1033



DCO.1053



DCO.1030

DCO.1031



D0700240



D0500459

D0500460



D0700241

The parts referenced in this catalog are not original, but are perfectly adaptable to the models to which they are intended. The use of the manufacturers' marks and the original references is done exclusively for the purpose of indicating the model to which each piece is destined.



The parts referenced in this catalog are not original, but are perfectly adaptable to the models to which they are intended.
The use of the manufacturers' marks and the original references is done exclusively for the purpose of indicating the model to which each piece is destined.

| DIESSA REF. | O.E.M. REF. | DESCRIPTION |
|-------------|-----------------------------------------------------------|-------------------------------------------------|
| DC0.0900 | 8143891,504111690 | FRONT GRILLE |
| DC0.0899 | 98438449,2997104 | BUMPER W/O FOG LAMP HOLE |
| DC0.1051 | 8143223,3798588 | STEP ON BUMPER |
| DC0.1049 | 8143003,98499858 | CENTRAL PLATE |
| DC0.1050 | 8143032 | FR LICENSE PLATE HOLDER |
| D0700069 | 98473849 | COVER BUMPER. DARK GREY |
| DI2.0681 | 41210252,41210253,41210254 | REAR HALF MUDGUARD RH/LH FRONT AND REAR SECTION |
| DC0.1072 | 41032399,2997165,0 | TOP MUDGUARD W/O STRAPE |
| DC0.1510 | 41032400,2997166 | TOP MUDGUARD W/O STRAPE |
| DC0.1040 | 41003236 | REAR MUDGUARD UPPER RH |
| DC0.1041 | 41002927,42125604 | REAR MUDGUARD UPPER LH |
| D0500134 | 42559051,42533556,5001842757 | RUBER STRAPE |
| DI2.0076 | 41032401,2997167 | REAR MUDGUARD RH=LH |
| DI2.0075 | 41032402,2997168 | REAR MUDGUARD CENTRE CURVING TYPE |
| DC0.1052 | 99805623,98438466,99805623 | FOOTBOARD R |
| DC0.1053 | 99805624,98438467,2997319 | FOOTBOARD L |
| D0600171 | 8144468,8144470,814446800 | REAR MUDGUARD LH |
| D0600172 | 8144469 | REAR MUDGUARD RH |
| DC0.1030 | 8144329 | FR MUDGUARD, R |
| DC0.1031 | 814432800,8144328 | FR MUDGUARD, L |
| D0700240 | 8144393,98442028 | FOOTSTEP RH |
| D0700241 | 8144394,98442029 | FOOTSTEP LH |
| DC0.1032 | 99805621 | FOOTBOARD, R |
| DC0.1033 | 99805622 | FOOTBOARD, L |
| D0500459 | 2997120 | FOOT BOARD, R |
| D0500460 | 4649176;299712100;2997121; 4949176;98466162;9846616200 | FOOT BOARD, L |
| D0600174 | 98474429 | BATTERY COVER |
| DC0.1047 | 3798587/8143222 | BUMPER GRILLE RH=LH ALUMINIUM |
| DC0.1002 | 8142607,3798586 | STEP PANEL |
| DC0.1017 | 3798585,8142610 | STEP PANEL, UPPER (R=L) |
| DC0.1018 | 3798584,8142611 | STEP PANEL, LOWER (R=L) |
| DC0.2132 | 500335296 | OUTSIDE HANDLE SET, 2 CVLS + 4KEYS |
| DC0.0990 | 98404709,98404713 | OUTSIDE HANDLE W/KEY RH [1 CYLINDER 2 KEYS] |

| DIESSA REF. | O.E.M. REF. | DESCRIPTION |
|-------------|---------------------------------------------------|--------------------------------------------------------------------|
| DC0.0991 | 98404710,98404714 | OUTSIDE HANDLE W/KEY LH [1 CYLINDER 2 KEYS] |
| DC0.1820 | 98472613,98407510 | INSIDE HANDLE, FRONT RH=LH |
| D0600063 | 2992664 | KEY CYLINDER [1 CYLINDER 2 KEYS] |
| D0500359 | 99487780,2997195 | ELECTRICAL WINDOW REGULATOR RH W/O MOTOR |
| DC0.0995 | 99487781,2997196 | ELECTRICAL WINDOW REGULATOR RH W/O MOTOR |
| D0600005 | 4861793 | HEAD LAMP RH MANUAL/ELECTRIC H4/H3/T4W |
| D0600006 | 4861794 | HEAD LAMP LH MANUAL/ELECTRIC H4/H3/T4W |
| D0600001 | 98437475 | FOG LAMP RH H3/H3 |
| D0600002 | 98437476 | FOG LAMP LH H3/H3 |
| D0500478 | 99463242,504094705 | TAIL LAMP RH W/O LICENSE LAMP R5W/P21W/P21W/R5W/R5W/P21W/P21W/R10W |
| D0500477 | 99463244,99463243,504094715 | TAIL LAMP LH W/O LICENSE LAMP R5W/P21W/P21W/R5W/R5W/P21W/P21W/R10W |
| D0500295 | 98460036 | CORNER HEAD LAMP RH P21W |
| D0500296 | 98460038 | CORNER HEAD LAMP LH P21W |
| DC2.3149 | 504001931 | REFLECTOR |
| DC2.3146 | 98459204 | HEAD LAMP PROTECTOR |
| DI2.0894 | 98472983,8143122 | MAIN MIRROR RH CLASS II ELECTRIC HEATED R1200 LHD |
| DI2.0891 | 98472979,98473007 | MAIN MIRROR LH CLASS II ELECTRIC HEATED R1200 LHD |
| D0500530 | 98472982,98473010,8143122 | MAIN MIRROR RH CLASS II MANUAL HEATED R1200 LHD |
| DI2.0848 | 98472977 | MAIN MIRROR LH CLASS II MANUAL HEATED R1200 LHD |
| DI2.0753 | 2996671,504132249 | WIDE ANGLE MIRROR RH=LH CLASS IV ELECTRIC HEATED R300 LHD |
| DI2.0752 | 2996670,504132248 | WIDE ANGLE MIRROR RH=LH CLASS IV MANUAL HEATED R300 LHD |
| D0500446 | 42548403,93193199,2997253 | MIRROR GLASS CLASS IV WIDE ANGLE RH=LH HEATED R300 LHD |
| D0500448 | 93190970 | MIRROR GLASS CLASS II RH=LH HEATED R1200 LHD |
| D0500447 | 93190976 | MIRROR GLASS CLASS II RH=LH HEATED R1200 LHD |
| DI0.0002 | 504132244,98409111,98472975, 98409260,98473002 | MIRROR ROOF CLASS V RH ELECTRIC HEATED R300 LHD |
| DI2.0897 | 504132243,98472974,98409110 | MIRROR ROOF CLASS V RH MANUAL HEATED R300 LHD |

IV EUROTRAKKER



DCO.2015



DCO.2016



DCO.2015



DCO.2016



D0600174



DCO.0992



DCO.1047



DCO.1018



D0500134



D0600172



DCO.1002

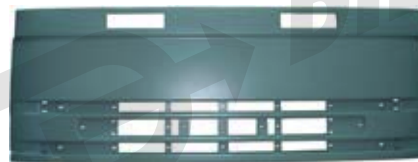

DCO.0900



DCO.1017



D0600171



DCO.1040



DCO.1030



DCO.1031



D0500459



D0500460



DCO.1041

The parts referenced in this catalog are not original, but are perfectly adaptable to the models to which they are intended. The use of the manufacturers' marks and the original references is done exclusively for the purpose of indicating the model to which each piece is destined.



DI2.0894
D0500530



DI2.0753
DI2.0752



DI2.0891
DI2.0848



D0500446



DI0.0002
DI2.0897



DI2.0030



DI2.0031



D0500448
D0500447



DI2.0452



DC2.3146



DI2.0451

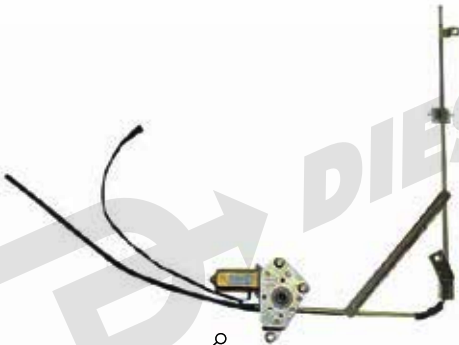

D0500359



D0500478



D0500477



DC0.0995

The parts referenced in this catalog are not original, but are perfectly adaptable to the models to which they are intended.
The use of the manufacturers' marks and the original references is done exclusively for the purpose of indicating the model to which each piece is destined.

IV EUROTRAKKER



| DIESSA REF. | O.E.M. REF. | DESCRIPTION |
|-------------|----------------------------------------------------------------|---------------------------------------------------|
| DC0.0900 | 8143891,504111690 | FRONT GRILLE |
| DC0.0992 | 8143812 | FRONT VALANCE PANEL RH |
| DC0.0993 | 8143813 | FRONT VALANCE PANEL LH |
| DC0.2015 | 504103233,504053093, 2997524 | FOOTBOARD (GREY), RH |
| DC0.2016 | 504103232,504053092, 2997523 | FOOTBOARD (GREY), LH |
| DC0.1040 | 41003236 | REAR MUDGUARD UPPER RH |
| DC0.1041 | 41002927,42125604 | REAR MUDGUARD UPPER LH |
| D0500134 | 42559051,42533556, 5001842757 | RUBER STRAPE |
| D0600171 | 8144468,8144470, 814446800 | REAR MUDGUARD LH |
| D0600172 | 8144469 | REAR MUDGUARD RH |
| DC0.1030 | 8144329 | FR MUDGUARD, R |
| DC0.1031 | 814432800; 8144328 | FR MUDGUARD, L |
| D0500459 | 2997120;7184091; 98466161; 299712000 | FOOT BOARD, R |
| D0500460 | 4649176;299712100; 2997121; 4949176;98466162; 9846616200 | FOOT BOARD, L |
| D0600174 | 98474429 | BATTERY COVER |
| DC0.1047 | 3798587/8143222 | BUMPER GRILLE RH=LH ALUMINIUM |
| DC0.1002 | 8142607,3798586 | STEP PANEL |
| DC0.1017 | 3798585,8142610 | STEP PANEL, UPPER (R=L) |
| DC0.1018 | 3798584,8142611 | STEP PANEL, LOWER (R=L) |
| D0500359 | 99487780,2997195 | ELECTRICAL WINDOW REGULATOR RH W/O MOTOR |
| DC0.0995 | 99487781,2997196 | ELECTRICAL WINDOW REGULATOR RH W/O MOTOR |
| DI2.0030 | 500314717 | SUN VISOR'S MARKER RH BLACK |
| DI2.0031 | 500314716 | SUN VISOR'S MARKER LH BLACK |
| DI2.0452 | 98461649 | SUN VISOR'S MARKER RH SILVER |
| DI2.0451 | 98461648 | SUN VISOR'S MARKER LH SILVER |
| D0500478 | 37650000,99463242 | TAIL LAMP RH R5W/P21W/P21W/R5W/R5W/P21W/P21W/R10W |
| D0500477 | 504094715,99463244 | TAIL LAMP LH R5W/P21W/P21W/R5W/R5W/P21W/P21W/R10W |
| DC2.3146 | 98459204 | HEAD LAMP PROTECTOR |
| DI2.0894 | 98472983 | MAIN MIRROR RH CLASS II ELECTRIC HEATED R1200 LHD |

| DIESSA REF. | O.E.M. REF. | DESCRIPTION |
|-------------|-------------------------------------------------------|-----------------------------------------------------------|
| D0700066 | 98472979,98473007 | MAIN MIRROR LH CLASS II ELECTRIC HEATED R1200 LHD |
| D0500530 | 98472982,98473010, 8143122 | MAIN MIRROR RH CLASS II MANUAL HEATED R1200 LHD |
| DI2.0848 | 98472977 | MAIN MIRROR LH CLASS II MANUAL HEATED R1200 LHD |
| DI2.0753 | 2996671,504132249 | WIDE ANGLE MIRROR RH=LH CLASS IV ELECTRIC HEATED R300 LHD |
| DI2.0752 | 2996670,504132248 | WIDE ANGLE MIRROR RH=LH CLASS IV MANUAL HEATED R300 LHD |
| D0500446 | 42548403,93193199, 2997253 | MIRROR GLASS CLASS IV WIDE ANGLE RH=LH HEATED R300 LHD |
| D0500448 | 93190970 | MIRROR GLASS CLASS II RH=LH HEATED R1200 LHD |
| D0500447 | 93190976 | MIRROR GLASS CLASS II RH=LH HEATED R1200 LHD |
| DIO.0002 | 504132244,98409111, 98472975, 98409260 98473002 | MIRROR ROOF CLASS V RH ELECTRIC HEATED R300 LHD |
| DI2.0897 | 504132243,98472974, 98409110 | MIRROR ROOF CLASS V RH MANUAL HEATED R300 LHD |

IV EURO CARGO 60



DC2.3157



DC2.3179



DC0.1804



D0700069

DC0.0992



DC0.1010



DC0.1812



DC2.3180



DC0.1805



DC0.0993



D0500456



DC0.0996



DC0.1002



DC0.1011



DC0.1791



DC0.0997



D0600174



DC0.1000



D0500470



DC0.1001

The parts referenced in this catalog are not original, but are perfectly adaptable to the models to which they are intended. The use of the manufacturers' marks and the original references is done exclusively for the purpose of indicating the model to which each piece is destined.



The parts referenced in this catalog are not original, but are perfectly adaptable to the models to which they are intended. The use of the manufacturers' marks and the original references is done exclusively for the purpose of indicating the model to which each piece is destined.

IV EUROCARGO 60



| DIESSA REF. | O.E.M. REF. | DESCRIPTION |
|-------------|-----------------------------------|------------------------------------------|
| DC0.1011 | 500316865,2997106 | FRONT BUMPER. DARK GREY |
| DC0.1010 | 8142590,2997103 | FRONT BUMPER. LIGHT GREY |
| D0500470 | 504110983,504110983 8142413 | FRONT GRILLE |
| DC0.0992 | 8143812,8143812 | FRONT VALANCE PANEL RH |
| DC0.0993 | 8143813,8143813 | FRONT VALANCE PANEL LH |
| DC0.1804 | 98494104,98494104, 8143174 | BUMPER ELEMENT, RH |
| DC0.1805 | 98494105,98494105, 9849410500 | BUMPER ELEMENT, LH |
| D0700069 | 98473849,98473849 | COVER BUMPER. DARK GREY |
| D0500456 | 98464670,98464670 | COVER BUMPER. LIGHT GREY |
| DC2.3157 | 8143901,8143901 | SIDE COVER, RH |
| DC0.1812 | 8143902,8143902 | SIDE COVER, LH |
| DC2.3179 | 98472647,98472647 | POCKET ON DARK GREY DOOR PANEL RH |
| DC2.3180 | 98472648,98472648 | POCKET ON DARK GREY DOOR PANEL LH |
| DC0.0996 | 8142603,8142603 | STAND PANEL, LOWER, R |
| DC0.0997 | 8142604,8142604 | STAND PANEL, LOWER, L |
| DC0.1000 | 500317944,500317944, 500317946 | STAND PANEL, LOWER (DARK), R |
| DC0.1001 | 500317945,500317945, 500317947 | STAND PANEL, LOWER (DARK), L |
| DC0.1002 | 8142607,8142607, 3798586 | STEP PANEL |
| DC0.1791 | 8142591,8142591 | STEP PANEL ON FRONT BUMPER |
| D0600174 | 98474429,98474429 | BATTERY COVER |
| DC0.2132 | 500335296 | OUTSIDE HANDLE SET, 2 CYLS + 4KEYS |
| DC0.0990 | 98404709,98404713 | OUTSIDE HANDLE W/1 CYL. 2KEYS, FRONT RH |
| DC0.0991 | 98404710,98404714 | OUTSIDE HANDLE W/1 CYL. 2KEYS, FRONT LH |
| D0500359 | 99487780,99487780 | ELECTRICAL WINDOW REGULATOR RH W/O MOTOR |
| DC0.0995 | 99487781,99487781 | ELECTRICAL WINDOW REGULATOR RH W/O MOTOR |
| DC0.1882 | 500340544,500340544, 500340503 | HEAD LAMP RH MANUAL H4/T4W |
| DC0.1883 | 500340543,500340543, 98432537 | HEAD LAMP LH MANUALH4/T4W |
| D0500286 | 500340361,500340361 | HEAD LAMP RH ELECTRIC H4/T4W |

| DIESSA REF. | O.E.M. REF. | DESCRIPTION |
|-------------|----------------------------------|-------------------------------------------------|
| D0500287 | 500340408,500340408 | HEAD LAMP LH ELECTRIC H4/T4W |
| D0600001 | 98437475,98437475 | FOG LAMP UNIT RH H3/H3 |
| D0600002 | 98437476,98437476 | FOG LAMP UNIT LH H3/H3 |
| DI2.0030 | 500314717,500314717 | SUN VISOR'S MARKER RH BLACK |
| DI2.0031 | 500314716,500314716 | SUN VISOR'S MARKER LH BLACK |
| DI2.0452 | 98461649,98461649 | SUN VISOR'S MARKER RH SILVER |
| DI2.0451 | 98461648,98461648 | SUN VISOR'S MARKER LH SILVER |
| D0500289 | 4855967,4855967, 500340695 | CORNER LAMP RH P21W |
| D0500292 | 4855968,4855968, 500340696 | CORNER LAMP LH P21W |
| DI2.0029 | 500382617, 98421202 | TAIL LAMP RH 5 FUNCTIONS P21W/P21W/R5W/R5W/P21W |
| DI2.0028 | 500382616,500382616, 98421203 | TAIL LAMP LH 5 FUNCTIONS P21W/P21W/R5W/R5W/P21W |

IV EURO CARGO 120



DC2.3157

DC2.3179

DC2.3147

D0700069

DC0.0992

DC0.1027

DC0.0993

D0500456

DC0.1015

DC0.1026

D0500470

DC0.1016

DC0.1013

DC0.1014

DC0.1812

DC2.3180

DC0.1897

The parts referenced in this catalog are not original, but are perfectly adaptable to the models to which they are intended.
The use of the manufacturers' marks and the original references is done exclusively for the purpose of indicating the model to which each piece is destined.

IV EUROCARGO 120



DCO.2132



DCO.0990



D0600174



DCO.0991



DCO.0995

D0500359



DCO.1882



DCO.1883

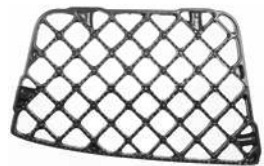

DCO.1002



D0500286



D0500287



DCO.1791



DCO.1017



D0600001



D0600002



DCO.1018

The parts referenced in this catalog are not original, but are perfectly adaptable to the models to which they are intended. The use of the manufacturers' marks and the original references is done exclusively for the purpose of indicating the model to which each piece is destined.

IV EUROCARGO 120



DI2.0894

DI2.0893



DI2.0753
DI2.0752



DI0.0002
DI2.0897



DI2.0030



DI2.0031



DI2.0452



D0500289



D0500292



DI2.0451



DI2.0028



DI2.0029



D0500446



DI2.0891

DI2.0848



D0500448
D0500447

The parts referenced in this catalog are not original, but are perfectly adaptable to the models to which they are intended.
The use of the manufacturers' marks and the original references is done exclusively for the purpose of indicating the model to which each piece is destined.

| DIESSA REF. | O.E.M. REF. | DESCRIPTION |
|-------------|--------------------------------|------------------------------------------|
| DC0.1027 | 500317137 | BUMPER (DARK-GRAY) |
| DC0.1026 | 8142601 | FRONT BUMPER. LIGHT GREY |
| D0500470 | 504110983,8142413 | FRONT GRILLE |
| DC0.0992 | 8143812 | FRONT VALANCE PANEL RH |
| DC0.0993 | 8143813 | FRONT VALANCE PANEL LH |
| DC2.3147 | 500319051,8143224, 98494256 | BUMPER ELEMENT, RH |
| DC0.1897 | 500319052,8143225, 98494257 | BUMPER ELEMENT, LH |
| D0700069 | 98473849 | COVER BUMPER. DARK GREY |
| D0500456 | 98464670 | COVER BUMPER. LIGHT GREY |
| DC2.3157 | 8143901 | SIDE COVER, RH |
| DC0.1812 | 8143902 | SIDE COVER, LH |
| DC2.3179 | 98472647 | POCKET ON DARK GREY DOOR PANEL RH |
| DC2.3180 | 98472648 | POCKET ON DARK GREY DOOR PANEL LH |
| DC0.1015 | 500317956 | LOWER STAND PANEL (BLK) R |
| DC0.1016 | 500318079 | LOWER STAND PANEL (BLK) L |
| DC0.1013 | 8142605 | LOWER STAND PANEL (GRAY), R |
| DC0.1014 | 8142609 | LOWER STAND PANEL (GRAY), L |
| DC0.1017 | 3798585,8142610 | STEP PANEL, UPPER (R=L) |
| DC0.1018 | 3798584,8142611 | STEP PANEL, LOWER (R=L) |
| DC0.1002 | 8142607,3798586 | STEP PANEL |
| DC0.1791 | 8142591 | STEP PANEL ON FRONT BUMPER |
| D0600174 | 98474429 | BATTERY COVER |
| DC0.2132 | 500335296 | OUTSIDE HANDLE SET, 2 CYLS + 4 KEYS |
| DC0.0990 | 98404709,98404713 | OUTSIDE HANDLE W/1 CYL. 2KEYS, FRONT RH |
| DC0.0991 | 98404710,98404714 | OUTSIDE HANDLE W/1 CYL. 2KEYS, FRONT LH |
| D0500359 | 99487780,2997195 | ELECTRICAL WINDOW REGULATOR RH W/O MOTOR |
| DC0.0995 | 99487781,2997196 | ELECTRICAL WINDOW REGULATOR RH W/O MOTOR |
| DC0.1882 | 500340544, 500340503 | HEAD LAMP RH MANUAL H4/T4W |
| DC0.1883 | 500340543, 98432537 | HEAD LAMP LH MANUAL H4/T4W |
| D0500286 | 500340361 | HEAD LAMP RH ELECTRIC H4/T4W |
| D0500287 | 500340408 | HEAD LAMP LH ELECTRIC H4/T4W |
| D0600001 | 98437475 | FOG LAMP UNIT RH H3/H3 |

| DIESSA REF. | O.E.M. REF. | DESCRIPTION |
|-------------|-------------------------------------------------------|-----------------------------------------------------------------------------|
| D0600002 | 98437476 | FOG LAMP UNIT LH H3/H3 |
| DI2.0030 | 500314717 | SUN VISOR'S MARKER RH BLACK |
| DI2.0031 | 500314716 | SUN VISOR'S MARKER LH BLACK |
| DI2.0452 | 98461649 | SUN VISOR'S MARKER RH SILVER |
| DI2.0451 | 98461648 | SUN VISOR'S MARKER LH SILVER |
| D0500289 | 4855967,500340695 | CORNER LAMP RH P21W |
| D0500292 | 4855968,500340696 | CORNER LAMP LH P21W |
| DI2.0029 | 500382617,98421202 | TAIL LAMP RH 5 FUNCTIONS P21W/P21W/R5W/R5W/P21W |
| DI2.0028 | 500382616,98421203 | TAIL LAMP LH 5 FUNCTIONS P21W/P21W/R5W/R5W/P21W |
| D0700068 | 8143122, 98473011 | MAIN MIRROR RH=LH CLASS II ELECTRIC HEATED R1200 LHD Eurocargo 09/00 -03/06 |
| D0700066 | 98472979,98473007 | MAIN MIRROR LH CLASS II ELECTRIC HEATED R1200 LHD |
| DI2.0848 | 98472977 | MAIN MIRROR LH CLASS II MANUAL HEATED R1200 LHD |
| DI2.0753 | 2996671,504132249 | WIDE ANGLE MIRROR RH=LH CLASS IV ELECTRIC HEATED R300 LHD |
| DI2.0752 | 2996670,504132248 | WIDE ANGLE MIRROR RH=LH CLASS IV MANUAL HEATED R300 LHD |
| D0500446 | 42548403,93193199, 2997253 | MIRROR GLASS CLASS IV WIDE ANGLE RH=LH HEATED R300 LHD |
| D0500448 | 93190970 | MIRROR GLASS CLASS II RH=LH HEATED R1200 LHD |
| D0500447 | 93190976 | MIRROR GLASS CLASS II RH=LH HEATED R1200 LHD |
| DI0.0002 | 504132244,98409111, 98472975, 98409260 98473002 | MIRROR ROOF CLASS V RH ELECTRIC HEATED R300 LHD |
| DI2.0897 | 504132243,98472974, 98409110 | MIRROR ROOF CLASS V RH MANUAL HEATED R300 LHD |

IV EUROCARGO 150



DC2.3157



DCO.1812



DCO.1002



DCO.1791



DCO.1017



DCO.1018



DCO.2118



D0600174



DCO.0992



DCO.0993



D0500359



D0700069



D0500470



D0500456



DCO.0995

The parts referenced in this catalog are not original, but are perfectly adaptable to the models to which they are intended. The use of the manufacturers' marks and the original references is done exclusively for the purpose of indicating the model to which each piece is destined.

IV EUROCARGO 150



The parts referenced in this catalog are not original, but are perfectly adaptable to the models to which they are intended.
The use of the manufacturers' marks and the original references is done exclusively for the purpose of indicating the model to which each piece is destined.

IV EUROARGO 150



| DIESSA REF. | O.E.M. REF. | DESCRIPTION |
|-------------|-----------------------------|-----------------------------------------------------------------------------|
| DC0.2118 | 500317145 | FRONT BUMPER DARK GREY |
| D0500470 | 504110983,8142413 | FRONT GRILLE |
| DC0.0992 | 8143812 | FRONT VALANCE PANEL RH |
| DC0.0993 | 8143813 | FRONT VALANCE PANEL LH |
| D0700069 | 98473849 | COVER BUMPER. DARK GREY |
| D0500456 | 98464670 | COVER BUMPER. LIGHT GREY |
| DC2.3157 | 8143901 | SIDE COVER, RH |
| DC0.1812 | 8143902 | SIDE COVER, LH |
| DC0.1017 | 3798585,8142610 | STEP PANEL, UPPER (R=L) |
| DC0.1018 | 3798584,8142611 | STEP PANEL, LOWER (R=L) |
| DC0.1002 | 8142607,3798586 | STEP PANEL |
| DC0.1791 | 8142591 | STEP PANEL ON FRONT BUMPER |
| D0600174 | 98474429 | BATTERY COVER |
| D0500359 | 99487780,2997195 | ELECTRICAL WINDOW REGULATOR RH W/O MOTOR |
| DC0.0995 | 99487781,2997196 | ELECTRICAL WINDOW REGULATOR RH W/O MOTOR |
| DC0.1882 | 500340544,500340503 | HEAD LAMP RH MANUAL H4/T4W |
| DC0.1883 | 500340543,98432537 | HEAD LAMP LH MANUALH4/T4W |
| D0500286 | 500340361 | HEAD LAMP RH ELECTRIC H4/T4W |
| D0500287 | 500340408 | HEAD LAMP LH ELECTRIC H4/T4W |
| D0600001 | 98437475 | FOG LAMP UNIT RH H3/H3 |
| D0600002 | 98437476 | FOG LAMP UNIT LH H3/H3 |
| DI2.0030 | 500314717 | SUN VISOR'S MARKER RH BLACK |
| DI2.0031 | 500314716 | SUN VISOR'S MARKER LH BLACK |
| DI2.0452 | 98461649 | SUN VISOR'S MARKER RH SILVER |
| DI2.0451 | 98461648 | SUN VISOR'S MARKER LH SILVER |
| D0500289 | 4855967,500340695 | CORNER LAMP RH P21W |
| D0500292 | 4855968,500340696 | CORNER LAMP LH P21W |
| DI2.0029 | 500382617,98421202 | TAIL LAMP RH 5 FUNCTIONS P21W/P21W/R5W/R5W/P21W |
| DI2.0028 | 500382616,98421203 | TAIL LAMP LH 5 FUNCTIONS P21W/P21W/R5W/R5W/P21W |
| D0700068 | 8143122, 98473011 | MAIN MIRROR RH=LH CLASS II ELECTRIC HEATED R1200 LHD Eurocargo 09/00 -03/06 |
| D0700066 | 98472979,98473007 | MAIN MIRROR LH CLASS II ELECTRIC HEATED R1200 LHD |
| D0500530 | 98472982, 98473010, 8143122 | MAIN MIRROR RH CLASS II MANUAL HEATED R1200 LHD |

| DIESSA REF. | O.E.M. REF. | DESCRIPTION |
|-------------|---------------------------------------------------|-----------------------------------------------------------|
| DI2.0848 | 98472977 | MAIN MIRROR LH CLASS II MANUAL HEATED R1200 LHD |
| DI2.0753 | 2996671,504132249 | WIDE ANGLE MIRROR RH=LH CLASS IV ELECTRIC HEATED R300 LHD |
| DI2.0752 | 2996670,504132248 | WIDE ANGLE MIRROR RH=LH CLASS IV MANUAL HEATED R300 LHD |
| D0500446 | 42548403,93193199, 2997253 | MIRROR GLASS CLASS IV WIDE ANGLE RH=LH HEATED R300 LHD |
| D0500448 | 93190970 | MIRROR GLASS CLASS II RH=LH HEATED R1200 LHD |
| D0500447 | 93190976 | MIRROR GLASS CLASS II RH=LH HEATED R1200 LHD |
| DI0.0002 | 504132244, 98409111, 98472975, 98409260, 98473002 | MIRROR ROOF CLASS V RH ELECTRIC HEATED R300 LHD |
| DI2.0897 | 504132243, 98472974, 98409110 | MIRROR ROOF CLASS V RH MANUAL HEATED R300 LHD |

IV STRALIS AS



The parts referenced in this catalog are not original, but are perfectly adaptable to the models to which they are intended.
The use of the manufacturers' marks and the original references is done exclusively for the purpose of indicating the model to which each piece is destined.

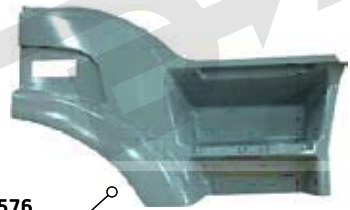

DC0.1576



DC0.1577



DI2.0849



DC0.0856



DC0.0857



DI2.0850



DC0.2033



DC0.2031

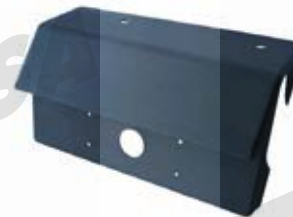

DC0.2032



DC0.2034

The parts referenced in this catalog are not original, but are perfectly adaptable to the models to which they are intended.
The use of the manufacturers' marks and the original references is done exclusively for the purpose of indicating the model to which each piece is destined.



DCO.1072



DCO.1510



D0700070



DI2.0857



DI2.0681



X2



X2



X2



X2



D0700285



DCO.1041



DCO.1040



D0600174



D0700279



DCO.0858



D0500263



D0500264



DCO.0859

The parts referenced in this catalog are not original, but are perfectly adaptable to the models to which they are intended. The use of the manufacturers' marks and the original references is done exclusively for the purpose of indicating the model to which each piece is destined.

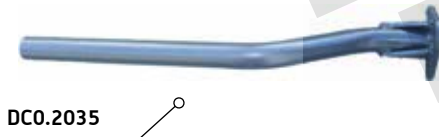
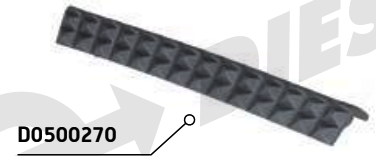
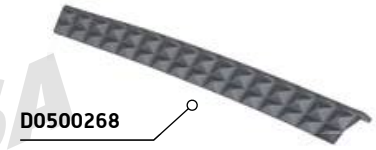
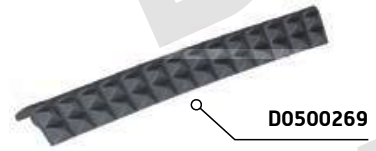
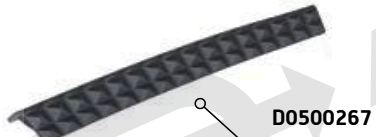

D0500582
D0500290
(manual)
DI2.0858
(electric chrome)



D0500583
D0500291
(manual)
DI2.0859
(electric chrome)

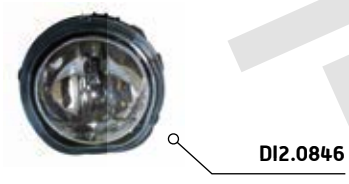
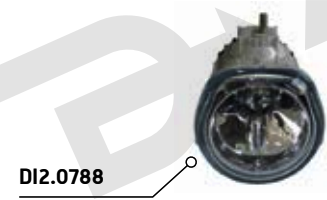
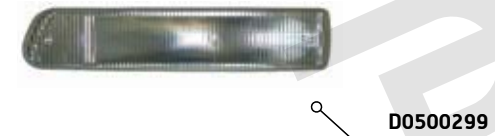
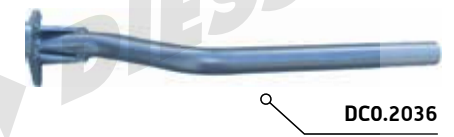
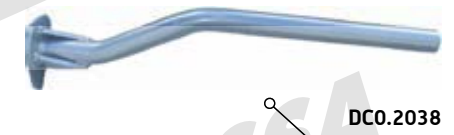

The parts referenced in this catalog are not original, but are perfectly adaptable to the models to which they are intended.
The use of the manufacturers' marks and the original references is done exclusively for the purpose of indicating the model to which each piece is destined.

IV STRALIS AS



DI2.0894
D0500530



DI2.0753
DI2.0752



DI0.0002
DI2.0897



DI2.0891

DI2.0848



D0500446



D0500448
D0500447



D0500478



D0500331



D0500330



D0500477



D0500478



D0500477

The parts referenced in this catalog are not original, but are perfectly adaptable to the models to which they are intended. The use of the manufacturers' marks and the original references is done exclusively for the purpose of indicating the model to which each piece is destined.

| DIESSA REF. | O.E.M. REF. | DESCRIPTION |
|-------------|--------------------------------|---------------------------------------------|
| DC0.0854 | 500383946,500364901,504103125 | FR BUMPER |
| DI2.0852 | 504103124 | FR BUMPER W/O FOG LAMP HOLE (AS) NEW |
| DC0.0855 | 500398112,504036171 | GRILLE DARK GREY |
| D0600077 | 504065985 | CORNER SPOILER RH |
| D0500347 | 504065984 | CORNER SPOILER LH |
| D0500343 | 500380098 | CORNER SPOILER LH |
| D0500342 | 500380099 | CORNER SPOILER RH |
| D0500341 | 500380096 | LOWER BUMPER SPOILER |
| D0500094 | 500380111,504032325 | STEP ON BUMPER |
| D0500461 | 504041243 | FR BUMPER CAP |
| D0500346 | 504065982 | MIDDLE SPOILER, RH |
| D0500348 | 504074676 | MIDDLE SPOILER, LH |
| D0500593 | 504215019,504052936 | OUTSIDE HANDLE SET, 2 CYLS + 4KEYS |
| DI2.0220 | 504052936R | OUTSIDE HANDLE W/KEY RH (1 CYLINDER 2 KEYS) |
| DC0.2026 | 504052936L | OUTSIDE HANDLE W/KEY LH (1 CYLINDER 2 KEYS) |
| D0500359 | 99487780,2997195 | ELECTRICAL WINDOW REGULATOR RH W/O MOTOR |
| DC0.0995 | 99487781,2997196 | ELECTRICAL WINDOW REGULATOR RH W/O MOTOR |
| DI2.0039 | 98472610 | INSIDE DOOR HANDLE RH=LH |
| DC2.3149 | 504001931 | REFLECTOR |
| D0600063 | 2992664 | KEY CYLINDER (1 CYLINDER 2 KEYS) |
| DC2.3150 | 504045315,504045318 | PILLAR GARNISH, RH |
| DC2.3151 | 504045316,504045319 | PILLAR GARNISH, LH |
| D0500349 | 504096162,504036807 | AIR DEFLECTOR (AS), RH |
| D0500350 | 504096163,504036808 | AIR DEFLECTOR (AS), LH |
| DC0.1576 | 504103308,5801840545,500375667 | FRONT FENDER W/ HOLE, RH (AS) |
| DC0.1577 | 5801840550,504103307 | FRONT FENDER W/ HOLE, LH (AS) |
| DC0.0856 | 500375431,504103304,2997119 | FOOTBOARD (BLACK), RH |
| DC0.0857 | 500375430,504103303,2997118 | FOOTBOARD (BLACK), LH |
| DI2.0849 | 504215973,504083111,2997579 | FOOTBOARD (LIGHT GREY), RH |
| DI2.0850 | 504215971,504083110,2997578 | FOOTBOARD (LIGHT GREY), LH |

| DIESSA REF. | O.E.M. REF. | DESCRIPTION |
|-------------|-------------------------------|-------------------------------------------------|
| DC0.2031 | 41218984 | SIDE LIGHT HOLDER RH DARK GREY |
| DC0.2032 | 41218983 | SIDE LIGHT HOLDER LH DARK GREY |
| DC0.2033 | 41213720 | CAP ON MUDGUARD RH |
| DC0.2034 | 41213721 | CAP ON MUDGUARD LH |
| DC0.1510 | 41032400,2997166 | TOP MUDGUARD W/O STRAPE |
| DC0.1072 | 41032399,2997165 | TOP MUDGUARD W/O STRAPE |
| D0700070 | 41213750,41213691,41298975 | TOP MUDGUARD W/O STRAPE |
| DI2.0857 | 41213751,41298976,41213692 | TOP MUDGUARD RH/LH FLAT TYPE |
| D0700285 | 41213754 | REAR HALF MUDGUARD RH/LH LONG |
| DI2.0681 | 41210252,41210253,41210254 | REAR HALF MUDGUARD RH/LH FRONT AND REAR SECTION |
| DC0.0859 | 504003993,504208707 | REAR MUDGUARD RH GREY |
| DC0.0859 | 504003992,504208706 | REAR MUDGUARD LH GREY |
| DC0.1040 | 41003236 | REAR MUDGUARD UPPER RH |
| DC0.1041 | 41002927,42125604 | REAR MUDGUARD UPPER LH |
| D0500263 | 504044980,504211611,504029044 | DOOR EXTENSION RH |
| D0500264 | 504044981,504211612,504029045 | DOOR EXTENSION LH |
| D0500267 | 504001361 | UPPER EXTENSION, FOOTBOARD, RH |
| D0500268 | 504001358 | UPPER EXTENSION, FOOTBOARD, LH |
| D0500269 | 504001345 | LOWER EXTENSION, FOOTBOARD, RH |
| D0500270 | 504001344 | LOWER EXTENSION, FOOTBOARD, LH |
| D0700279 | 41213696 | RUBBER STRAP |
| DC0.2038 | 41213729 | MUDGUARD SUPPORT LH |
| DC0.2037 | 41213731 | MUDGUARD SUPPORT RH |
| DC0.2036 | 41213725 | MUDGUARD SUPPORT LH |
| DC0.2035 | 41213727 | MUDGUARD SUPPORT RH |
| D0600174 | 98474429 | BATTERY COVER |
| D0500582 | 41221015 | HEAD LAMP ELEC/MAN, RH H7/H7/W5W/ |
| D0500583 | 41221036 | HEAD LAMP ELEC/MAN, LH H7/H7/W5W/ |
| D0500298 | 42555022,41221040 | CORNER LAMP, RH PV21W |
| D0500299 | 42555023,41221041 | CORNER LAMP, LH PV21W |

| DIESSA REF. | O.E.M. REF. | DESCRIPTION |
|-------------|---------------------------------|------------------------------------------------------------------------|
| DI2.0051 | 41221084,504032148 | INNER HIGH BEAM LAMP, RH=LH H1 |
| DI2.0050 | 41221083,504032145 | FOG LAMP OUTER, RH=LH H1 |
| DI2.0788 | 504181095 | FOG LAMP OUTER, RH=LH H1 |
| DI2.0846 | 504181096 | HIGH BEAM LAMP (INNER) RH=LH H1 |
| DI2.0030 | 500314717 | SUN VISOR'S MARKER RH BLACK |
| DI2.0031 | 500314716 | SUN VISOR'S MARKER LH BLACK |
| DI2.0452 | 98461649 | SUN VISOR'S MARKER RH SILVER |
| DI2.0451 | 98461648 | SUN VISOR'S MARKER LH SILVER |
| D0500478 | 99463242,504094705 | TAIL LAMP RH W/O LICENSE LAMP R5W/P21W/P21W/R5W/R5W/P21W/ P21W/R10W |
| D0500331 | 41221029,504250984 | SIDE LAMP RH P21W |
| D0500330 | 41221039,504250958 | SIDE LAMP LH P21W |
| DI2.0894 | 98472983,8143122 | MAIN MIRROR RH CLASS II ELECTRIC HEATED R1200 LHD |
| D0700066 | 98472979,98473007 | MAIN MIRROR LH CLASS II ELECTRIC HEATED R1200 LHD |
| D0500530 | 98472982,98473010, 8143122 | MAIN MIRROR RH CLASS II MANUAL HEATED R1200 LHD |
| DI2.0848 | 98472977 | MAIN MIRROR LH CLASS II MANUAL HEATED R1200 LHD |
| DI2.0753 | 2996671,504132249 | WIDE ANGLE MIRROR RH=LH CLASS IV ELECTRIC HEATED R300 LHD |
| DI2.0752 | 2996670,504132248 | WIDE ANGLE MIRROR RH=LH CLASS IV MANUAL HEATED R300 LHD |
| D0500446 | 42548403,93193199, 2997253 | MIRROR GLASS CLASS IV WIDE ANGLE RH=LH HEATED R300 LHD |
| D0500448 | 93190970 | MIRROR GLASS CLASS II RH=LH HEATED R1200 LHD |
| D0500447 | 93190976 | MIRROR GLASS CLASS II RH=LH HEATED R1200 LHD |
| DI0.0002 | 504132244,98409111, 98472975 | MIRROR ROOF CLASS V RH ELECTRIC HEATED R300 LHD |
| DI2.0897 | 504132243,98472974, 98409110 | MIRROR ROOF CLASS V RH MANUAL HEATED R300 LHD |
| DC0.0858 | 504003993,504208707 | REAR MUDGUARD RH GREY |
| D0500290 | 504020189 | HEAD LAMP RH MANUAL H7/H7/W5W/ |
| D0500291 | 504020193 | HEAD LAMP LH MANUAL H7/H7/W5W/ |
| DI2.0858 | 504238203 | HEAD LAMP RH ELECTRIC CHROME H7/H7/W5W/ |
| DI2.0859 | 504238213 | HEAD LAMP LH ELECTRIC CHROME H7/H7/W5W/ |

IV STRALIS AD/AT



The parts referenced in this catalog are not original, but are perfectly adaptable to the models to which they are intended.
The use of the manufacturers' marks and the original references is done exclusively for the purpose of indicating the model to which each piece is destined.



DI2.0786



DC0.2012



D0500259



D0500260



D0500261



D0500262



DC0.0856



DC0.0857



DI2.0849



DI2.0850



DC0.2033



DC0.2031

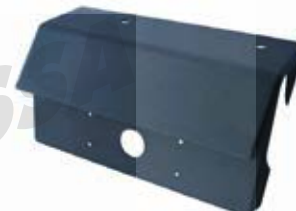

DC0.2032

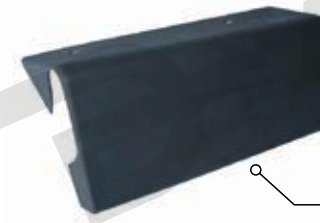

DC0.2034

The parts referenced in this catalog are not original, but are perfectly adaptable to the models to which they are intended.
The use of the manufacturers' marks and the original references is done exclusively for the purpose of indicating the model to which each piece is destined.

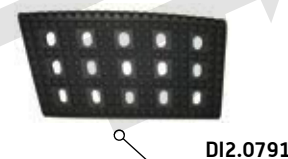
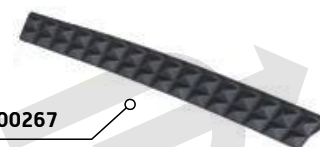

The parts referenced in this catalog are not original, but are perfectly adaptable to the models to which they are intended. The use of the manufacturers' marks and the original references is done exclusively for the purpose of indicating the model to which each piece is destined.



DCO.2037

DCO.2035

DCO.2038

DCO.2036

DI2.0030

DI2.0031

D0500331

DI2.0452

DI2.0451

D0500582

D0500290
(manual)

DI2.0858
(electric chrome)

D0500583

D0500291
(manual)

DI2.0859
(electric chrome)

D0500330



DI2.0894

D0500530



DI2.0891

DI2.0848

DI2.0753
DI2.0752



D10.0002
DI2.0897

D0500478

D0500478

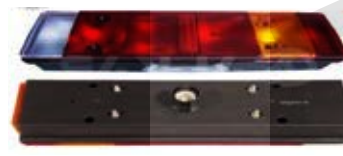

D0500299

D0500299

D0500477

D0500477

D0500477

D0500477



D0500446



D0500448
D0500447

The parts referenced in this catalog are not original, but are perfectly adaptable to the models to which they are intended. The use of the manufacturers' marks and the original references is done exclusively for the purpose of indicating the model to which each piece is destined.

| DIESSA REF. | O.E.M. REF. | DESCRIPTION |
|-------------|---------------------------------|---------------------------------------------|
| D0500256 | 500383947,504103112,50410311200 | FR BUMPER |
| DI2.0821 | 504103111,500366206,500386205 | FR BUMPER W/O FOG LAMP HOLE |
| D0500345 | 504056436 | FRONT GRILLE |
| D0600077 | 504065985 | CORNER SPOILER RH |
| D0500347 | 504065984 | CORNER SPOILER LH |
| D0500341 | 500380096 | LOWER BUMPER SPOILER |
| D0500094 | 500380111,504032325 | STEP ON BUMPER |
| D0500461 | 504041243 | FR BUMPER CAP |
| D0500346 | 504065982 | MIDDLE SPOILER, RH |
| D0500348 | 504074676 | MIDDLE SPOILER, LH |
| D0500593 | 504215019,504052936 | OUTSIDE HANDLE SET, 2 CYLS + 4KEYS |
| DI2.0220 | 504052936R | OUTSIDE HANDLE W/KEY RH (1 CYLINDER 2 KEYS) |
| DC0.2026 | 504052936L | OUTSIDE HANDLE W/KEY LH (1 CYLINDER 2 KEYS) |
| D0500359 | 99487780,2997195 | ELECTRICAL WINDOW REGULATOR RH W/O MOTOR |
| DC0.0995 | 99487781,2997196 | ELECTRICAL WINDOW REGULATOR RH W/O MOTOR |
| DI2.0039 | 98472610 | INSIDE DOOR HANDLE RH=LH |
| DC2.3148 | 504026820 | INNER HANDLE, RH |
| DC2.2797 | 504026821 | INNER HANDLE, LH |
| DC2.3149 | 504001931 | REFLECTOR |
| D0600063 | 2992664 | KEY CYLINDER (1 CYLINDER 2 KEYS) |
| DC2.3150 | 504045315,504045318 | PILLAR GARNISH, RH |
| DC2.3151 | 504045316,504045319 | PILLAR GARNISH, LH |
| D0500257 | 504056033 | AIR DEFLECTOR RH |
| D0500258 | 504056034,504203478 | AIR DEFLECTOR LH |
| DI2.0786 | 504156595,504065981 | LOWER FRAME, RH |
| DC0.2012 | 504156594,504065980 | LOWER FRAME, LH |
| D0500259 | 504103239,504047584 | FENDER, RH |
| D0500260 | 504103238,504047583,504211274 | FENDER, LH |
| D0500261 | 504047586,504103300 | FOOTBOARD MUDGUARD RH |
| D0500262 | 504047585,504103299 | FOOTBOARD MUDGUARD LH |

| DIESSA REF. | O.E.M. REF. | DESCRIPTION |
|-------------|-------------------------------|--------------------------------|
| DC0.0856 | 500375431/504103304,2997119 | FOOTBOARD (BLACK), RH |
| DC0.0857 | 500375430,504103303,2997118 | FOOTBOARD (BLACK), LH |
| DI2.0849 | 504215973,504083111,2997579 | FOOTBOARD (LIGHT GREY), RH |
| DI2.0850 | 504215971,504083110,2997578 | FOOTBOARD (LIGHT GREY), LH |
| DC0.2031 | 41218984 | SIDE LIGHT HOLDER RH DARK GREY |
| DC0.2032 | 41218983 | SIDE LIGHT HOLDER LH DARK GREY |
| DC0.2033 | 41213720 | CAP ON MUDGUARD RH |
| DC0.2034 | 41213721 | CAP ON MUDGUARD LH |
| DC0.1072 | 41032399,2997165 | TOP MUDGUARD W/O STRAPE |
| D0700070 | 41213750,41213691,41298975 | TOP MUDGUARD RH/LH |
| DI2.0857 | 41213751,41298976,41213692 | TOP MUDGUARD RH/LH FLAT TYPE |
| D0700285 | 41213754 | REAR HALF MUDGUARD RH/LH LONG |
| DC0.0858 | 504003993,504208707 | REAR MUDGUARD RH GREY |
| DC0.0859 | 504003992,504208706 | REAR MUDGUARD LH GREY |
| DC0.1040 | 41003236 | REAR MUDGUARD UPPER RH |
| DC0.1041 | 41002927,42125604 | REAR MUDGUARD UPPER LH |
| D0500263 | 504044980,504211611,504029044 | DOOR EXTENSION RH |
| D0500264 | 504044981,504211612,504029045 | DOOR EXTENSION LH |
| D0500267 | 504001361 | UPPER EXTENSION, FOOTBOARD, RH |
| D0500268 | 504001358 | UPPER EXTENSION, FOOTBOARD, LH |
| D0500269 | 504001345 | LOWER EXTENSION, FOOTBOARD, R |
| D0500270 | 504001344 | LOWER EXTENSION, FOOTBOARD, L |
| D0700279 | 41213696 | RUBBER STRAP |
| DC0.2038 | 41213729 | MUDGUARD SUPPORT LH |
| DC0.2037 | 41213731 | MUDGUARD SUPPORT RH |
| DC0.2036 | 41213725 | MUDGUARD SUPPORT LH |
| DC0.2035 | 41213727 | MUDGUARD SUPPORT RH |
| D0600174 | 98474429 | BATTERY COVER |

| DIESSA REF. | O.E.M. REF. | DESCRIPTION |
|-------------|-----------------------------------------------|--------------------------------------------------------------------|
| DI2.0803 | 504242108 | STEP PLATE RH |
| DI2.0791 | 504242109 | STEP PLATE LH |
| | 41221015 | HEAD LAMP ELEC/MAN, RH H7/H7/W5W/ |
| D0500583 | 41221036 | HEAD LAMP ELEC/MAN, LH H7/H7/W5W/ |
| D0500298 | 42555022,41221040 | CORNER LAMP, RH PV21W |
| D0500299 | 42555023,41221041 | CORNER LAMP, LH PV21W |
| DI2.0030 | 500314717 | SUN VISOR'S MARKER RH BLACK |
| DI2.0031 | 500314716 | SUN VISOR'S MARKER LH BLACK |
| DI2.0452 | 98461649 | SUN VISOR'S MARKER RH SILVER |
| DI2.0451 | 98461648 | SUN VISOR'S MARKER LH SILVER |
| D0500478 | 99463242,504094705 | TAIL LAMP RH W/O LICENSE LAMP R5W/P21W/P21W/R5W/R5W/P21W/P21W/R10W |
| D0500331 | 41221039,504250984 | SIDE LAMP RH P21W |
| D0500330 | 41221029,504250958,504098243 | SIDE LAMP LH P21W |
| DI2.0894 | 98472983,8143122 | MAIN MIRROR LH/RH CLASS II ELECTRIC HEATED R1800 LHD |
| D0700066 | 98472979,98473007 | MAIN MIRROR LH/RH CLASS II ELECTRIC HEATED R1800 LHD |
| D0500530 | 98472982,98473010,8143122 | MAIN MIRROR LH/RH CLASS II MANUAL HEATED R1800 LHD |
| DI2.0848 | 98472977 | MAIN MIRROR LH/RH CLASS II MANUAL HEATED R1800 LHD |
| DI2.0753 | 2996671,504132249 | MAIN MIRROR LH/RH CLASS IV ELECTRIC HEATED R300 LHD |
| DI2.0752 | 2996670,504132248 | WIDE ANGLE MIRROR RH/LH CLASS IV MANUAL HEATED R300 LHD |
| D0500446 | 42548403,93193199,2997253 | MIRROR GLASS CLASS IV WIDE ANGLE RH=LH HEATED R300 LHD |
| D0500448 | 93190970 | MIRROR GLASS CLASS II RH=LH HEATED R1200 LHD |
| D0500447 | 93190976 | MIRROR GLASS CLASS II RH=LH HEATED R1200 LHD |
| DI0.0002 | 504132244,98409111,98472975,98409260,98473002 | ROOF MIRROR CLASS V ELECTRIC LH/RH HEATED R300 |
| DI2.0897 | 504132243,98472974,98409110 | ROOF MIRROR CLASS V MANUAL LH/RH HEATED R300 |
| D0500290 | 504020189 | HEAD LAMP RH MANUAL H7/H7/W5W/ |
| D0500291 | 504020193 | HEAD LAMP LH MANUAL H7/H7/W5W/ |
| DI2.0858 | 504238203 | HEAD LAMP RH ELECTRIC CHROME H7/H7/W5W/ |
| DI2.0859 | 504238213 | HEAD LAMP LH ELECTRIC CHROME H7/H7/W5W/ |

IV TECTOR RESTYLING 75



DCO.1918

D0600174

D0700072

D0500592

D0600244

D0600245

D0500591

DI2.0220

D0600243

D0500463

D0500593

D0500582

D0500290
(manual)

DI2.0858
(electric chrome)



D0500462

D0500516

DCO.2026



DC2.3149

D0500583

D0500291
(manual)

DI2.0859
(electric chrome)



DCO.2119

D0600063

D0600248

DCO.1911

D0500600

D0600249

DCO.0995

D0500359

The parts referenced in this catalog are not original, but are perfectly adaptable to the models to which they are intended.
The use of the manufacturers' marks and the original references is done exclusively for the purpose of indicating the model to which each piece is destined.

| DIESSA REF. | O.E.M. REF. | DESCRIPTION |
|-------------|--------------------------------------------|---------------------------------------------|
| D0500600 | 504027461 | FR PANEL |
| D0700206 | 504027613,42554000, 2997370,504048251 | BUMPER W/O FOG LAMP HOLE (TECTOR) |
| DC0.2119 | 504027614,504048252, 2997638 | BUMPER W/FOG LAMP HOLE (TECTOR) |
| DC0.1918 | 504043051;50404305100 | BUMPER COVER |
| D0500463 | 500380095,504042188, 500383451 | COVER FR BUMPER, R |
| D0500462 | 500380094,504042187 | COVER FR BUMPER, L |
| D0700072 | 504042191,500380066 | BUMPER CAP |
| D0600248 | 504116074, 504060280 | CORNER PANEL, RH |
| D0600249 | 504116073,504060281, 504027463 | CORNER PANEL, LH |
| DC0.1911 | 504044637 | GRILLE |
| D0600244 | 504037735,504058445 | FR MUDGUARD RH |
| D0600245 | 504037737,504058446 | FR MUDGUARD LH |
| D0500582 | 504020189,41221015 | HEAD LAMP ELEC/MAN, RH H7/H7/W5W/ |
| D0500583 | 504020193,41221036 | HEAD LAMP ELEC/MAN, LH H7/H7/W5W/ |
| D0600243 | 504047573,504047579 | CORNER LAMP PY21W |
| D0500592 | 504043819 | UPPER STEP PLATE RH=LH |
| D0500591 | 504043817 | LOWER STEP PLATE R=L |
| D0500593 | 504215019,504052936 | OUTSIDE HANDLE SET, 2 CYLS + 4KEYS |
| DI2.0220 | 504052936R | OUTSIDE HANDLE W/KEY RH (1 CYLINDER 2 KEYS) |
| DC0.2026 | 504052936L | OUTSIDE HANDLE W/KEY LH (1 CYLINDER 2 KEYS) |
| D0500359 | 99487780,2997195 | ELECTRICAL WINDOW REGULATOR RH W/O MOTOR |
| DC0.0995 | 99487781,2997196 | ELECTRICAL WINDOW REGULATOR RH W/O MOTOR |
| DC2.3149 | 504001931 | REFLECTOR |
| D0600063 | 2992664 | KEY CYLINDER (1 CYLINDER 2 KEYS) |
| D0600174 | 98474429 | BATTERY COVER |
| D0500516 | 2997370, 42554000, 504027613, 504048251 | BUMPER W/O FOG LAMP HOLE (TECTOR) [SMC] |

IV TECTOR RESTYLING 125



DCO.1918



D0500592



D0500463



D0500517



D0500462



D0700072



D0600174



DCO.1921



D0700206



D0500600



DCO.1920



DCO.1919



D0600248



D0600249



DCO.1922



DCO.1911

The parts referenced in this catalog are not original, but are perfectly adaptable to the models to which they are intended. The use of the manufacturers' marks and the original references is done exclusively for the purpose of indicating the model to which each piece is destined.

IV TECTOR RESTYLING 125



TECTOR 2006 ->

TECTOR 2006 ->



DI2.0862



DI2.0055



DI2.0054

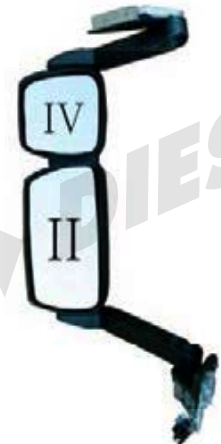

DI2.0861



DI2.0220



D0600063

D0500582
D0500290
(manual)
DI2.0858
(electric chrome)



D0500583
D0500291
(manual)
DI2.0859
(electric chrome)



D0500593

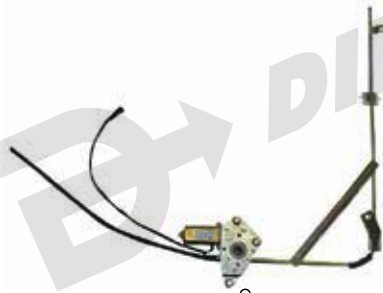

D0500359



D0500584



D0500585



D0600243



DC2.3149



DC0.2026



DC0.0995

The parts referenced in this catalog are not original, but are perfectly adaptable to the models to which they are intended.
The use of the manufacturers' marks and the original references is done exclusively for the purpose of indicating the model to which each piece is destined.

IV TECTOR RESTYLING 125



| DIESSA REF. | O.E.M. REF. | DESCRIPTION |
|-------------|-----------------------------------|----------------------------------------------|
| D0500600 | 504027461 | FR PANEL |
| D0500517 | 504027618,504049813, 500042692 | BUMPER W/O FOG LAMP HOLE (MEDIUM) |
| D0700206 | 504049814,500042691, 504027620 | BUMPER W/FOG LAMP HOLE (MEDIUM) |
| DC0.1918 | 504043051,50404305100 | BUMPER COVER |
| D0500463 | 500380095,504042188, 500383451 | COVER FR BUMPER, R |
| D0500462 | 500380094,504042187 | COVER FR BUMPER, L |
| D0700072 | 504042191,500380066 | BUMPER CAP |
| D0600248 | 504116074,504060280 | CORNER PANEL, RH |
| D0600249 | 504116073,504060281, 504027463 | CORNER PANEL, LH |
| DC0.1911 | 504044637;50404463700 | GRILLE |
| DC0.1921 | 504054940,504059309 | FR MUDGUARD RH FOR LOWERED WHEELS, WITH WING |
| DC0.1920 | 504054941 | FR MUDGUARD LH FOR LOWERED WHEELS, WITH WING |
| DC0.1919 | 504054942 | FR MUDGUARD RH |
| DC0.1922 | 504054943 | FR MUDGUARD LH |
| D0500582 | 504020189,41221015 | HEAD LAMP ELEC/MAN, RH H7/H7/W5W/ |
| D0500583 | 504020193,41221036 | HEAD LAMP ELEC/MAN, LH H7/H7/W5W/ |
| D0600243 | 504047573,504047579 | CORNER LAMP PY21W |
| D0500584 | 504052352 | FOG LAMP RH H1 |
| D0500585 | 504052353 | FOG LAMP LH H1 |
| D0500592 | 504043819 | UPPER STEP PLATE RH=LH |
| D0500593 | 504215019,504052936 | OUTSIDE HANDLE SET, 2 CYLS + 4 KEYS |
| DI2.0220 | 504052936R | OUTSIDE HANDLE W/KEY RH (1 CYLINDER 2 KEYS) |
| DC0.2026 | 504052936L | OUTSIDE HANDLE W/KEY LH (1 CYLINDER 2 KEYS) |
| D0500359 | 99487780,2997195 | ELECTRICAL WINDOW REGULATOR RH W/O MOTOR |
| DC0.0995 | 99487781,2997196 | ELECTRICAL WINDOW REGULATOR RH W/O MOTOR |
| DC2.3149 | 504001931 | REFLECTOR |
| D0600063 | 2992664 | KEY CYLINDER (1 CYLINDER 2 KEYS) |
| D0600174 | 98474429 | BATTERY COVER |
| D0500290 | 504020189 | HEAD LAMP RH MANUAL H7/H7/W5W/ |
| D0500291 | 504020193 | HEAD LAMP LH MANUAL H7/H7/W5W/ |
| DI2.0858 | 504238203 | HEAD LAMP RH ELECTRIC CHROME H7/H7/W5W/ |

| DIESSA REF. | O.E.M. REF. | DESCRIPTION |
|-------------|-------------|-----------------------------------------|
| DI2.0859 | 504238213 | HEAD LAMP LH ELECTRIC CHROME H7/H7/W5W/ |

IV TECTOR RESTYLING 155



DCO.1918



D0700072



D0500592



D0500591



D0500463



D0500517



D0500462



DCO.1921



D0700206



DCO.1920



D0600248



D0500600



D0600249



D0600174



DCO.1911

The parts referenced in this catalog are not original, but are perfectly adaptable to the models to which they are intended. The use of the manufacturers' marks and the original references is done exclusively for the purpose of indicating the model to which each piece is destined.

IV TECTOR RESTYLING 155



TECTOR 2006 ->

TECTOR 2006 ->



DI2.0862



DI2.0055



DI2.0054



DI2.0861



DI2.0220



D0600063

D0500582
D0500290
(manual)
DI2.0858
(electric chrome)



D0500583
D0500291
(manual)
DI2.0859
(electric chrome)



D0500593



DC0.2026



D0500359



D0500584



D0500585



D0600243



DC2.3149



DC0.0995

The parts referenced in this catalog are not original, but are perfectly adaptable to the models to which they are intended.
The use of the manufacturers' marks and the original references is done exclusively for the purpose of indicating the model to which each piece is destined.

IV TECTOR RESTYLING 155



| DIESSA REF. | O.E.M. REF. | DESCRIPTION |
|-------------|-----------------------------------------|----------------------------------------------|
| D0500600 | 504027461 | FR PANEL |
| D0500517 | 504027618,504049813,500042692 | BUMPER W/O FOG LAMP HOLE (MEDIUM) |
| D0700206 | 504027620,500042691,504049814,504049816 | BUMPER WITH FOG LAMP HOLE (TECTOR) |
| DC0.1918 | 504043051; 50404305100 | BUMPER COVER |
| D0500463 | 500380095,504042188,500383451 | COVER FR BUMPER, R |
| D0500462 | 500380094,504042187 | COVER FR BUMPER, L |
| D0700072 | 504042191,500380066 | BUMPER CAP |
| D0600248 | 504116074,504060280 | CORNER PANEL, RH |
| D0600249 | 504116073,504060281,504027463 | CORNER PANEL, LH |
| DC0.1911 | 504044637; 50404463700 | GRILLE |
| DC0.1921 | 504054940 | FR MUDGUARD RH FOR LOWERED WHEELS, WITH WING |
| DC0.1920 | 504054941 | FR MUDGUARD LH FOR LOWERED WHEELS, WITH WING |
| D0500582 | 504020189,41221015 | HEAD LAMP ELEC/MAN, RH H7/H7/W5W/ |
| D0500583 | 504020193,41221036 | HEAD LAMP ELEC/MAN, LH H7/H7/W5W/ |
| D0600243 | 504047573,504047579 | CORNER LAMP PY21W |
| D0500584 | 504052352 | FOG LAMP RH H1 |
| D0500585 | 504052353 | FOG LAMP LH H1 |
| D0500592 | 504043819 | UPPER STEP PLATE RH=LH |
| D0500591 | 504043817 | LOWER STEP PLATE R=L |
| D0500593 | 504215019,504052936 | OUTSIDE HANDLE SET, 2 CYLS + 4KEYS |
| DI2.0220 | 504052936R | OUTSIDE HANDLE W/KEY RH (1 CYLINDER 2 KEYS) |
| DC0.2026 | 504052936L | OUTSIDE HANDLE W/KEY LH (1 CYLINDER 2 KEYS) |
| D0500359 | 99487780, 2997195 | ELECTRICAL WINDOW REGULATOR RH W/O MOTOR |
| DC0.0995 | 99487781,2997196 | ELECTRICAL WINDOW REGULATOR RH W/O MOTOR |
| DC2.3149 | 504001931 | REFLECTOR |
| D0600063 | 2992664 | KEY CYLINDER (1 CYLINDER 2 KEYS) |
| D0600174 | 98474429 | BATTERY COVER |
| D0500290 | 504020189 | HEAD LAMP RH MANUAL H7/H7/W5W/ |
| D0500291 | 504020193 | HEAD LAMP LH MANUAL H7/H7/W5W/ |
| DI2.0858 | 504238203 | HEAD LAMP RH ELECTRIC CHROME H7/H7/W5W/ |
| DI2.0859 | 504238213 | HEAD LAMP LH ELECTRIC CHROME H7/H7/W5W/ |

| DIESSA REF. | O.E.M. REF. | DESCRIPTION |
|-----------------|--------------------------------|------------------------------------------------------------------------------------------------------------------------------------------------------|
| TECTOR 2006 --> | | |
| DI2.0862 | 504150552,504369995,5801341207 | COMPLETE MIRROR RH CLASS II+ CLASS IV, MAIN MIRROR H ELECTRIC CLASS II, WIDE ANGLE MIRROR ELECTRIC CLASS IV , HEATED BLACK LONG ARM, R1200 +R300 LHD |
| DI2.0861 | 504150551,504369979,5801341206 | COMPLETE MIRROR LH CLASS II+ CLASS IV, MAIN MIRROR H ELECTRIC CLASS II, WIDE ANGLE MIRROR ELECTRIC CLASS IV , HEATED BLACK LONG ARM, R1200 +R300 LHD |
| DI2.0055 | 504197879,2997668 | MIRROR GLASS CLASS IV WIDE ANGLE RH=LH HEATED R300 LHD |
| DI2.0054 | 504197878,504159282,504159284 | MIRROR GLASS CLASS II RH=LH HEATED R1200 LHD |

IV TECTOR RESTYLING 185



DC0.1918



D0700072



D0500589



D0500590



D0500463



D0500462



D0500592



D0500517



D0500591



D0500598



D0700206



D0500599



D0600248



D0500600



D0600249



D0600174



DC0.1911

The parts referenced in this catalog are not original, but are perfectly adaptable to the models to which they are intended. The use of the manufacturers' marks and the original references is done exclusively for the purpose of indicating the model to which each piece is destined.

IV TECTOR RESTYLING 185



TECTOR 2006 ->

TECTOR 2006 ->



DI2.0862



DI2.0055



DI2.0054

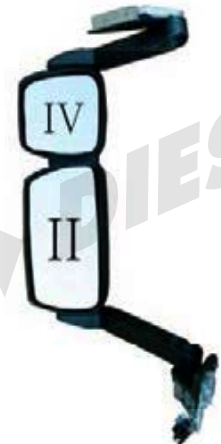

DI2.0861



DI2.0220



D0600063

D0500582

D0500290
(manual)

DI2.0858
(electric chrome)



D0500583

D0500291
(manual)

DI2.0859
(electric chrome)



D0500593



DC0.2026



D0500359



D0500584



D0500585



D0600243



DC2.3149



DC0.0995

The parts referenced in this catalog are not original, but are perfectly adaptable to the models to which they are intended.
The use of the manufacturers' marks and the original references is done exclusively for the purpose of indicating the model to which each piece is destined.

IV TECTOR RESTYLING 185



| DIESSA REF. | O.E.M. REF. | DESCRIPTION |
|-------------|-----------------------------------------------------------------|----------------------------------------------|
| D0500600 | 504027461 | FR PANEL |
| D0500517 | 504027618, 504049813, 500042692 504027618, 504049813, 500042692 | BUMPER W/O FOG LAMP HOLE (MEDIUM) |
| D0700206 | 504049814, 500042691, 504027620 | BUMPER W/FOG LAMP HOLE (MEDIUM) |
| DC0.1918 | 504043051;50404305100 | BUMPER COVER |
| D0500463 | 500380095,504042188, 500383451 | COVER FR BUMPER, R |
| D0500462 | 500380094,504042187 | COVER FR BUMPER, L |
| D0700072 | 504042191,500380066 | BUMPER CAP |
| D0600248 | 504116074,504060280 | CORNER PANEL, RH |
| D0600249 | 504116073,504060281, 504027463 | CORNER PANEL, LH |
| DC0.1911 | 504044637;50404463700 | GRILLE |
| D0500598 | 504055010 | FOOT STEP RH |
| D0500599 | 504055011 | FOOT STEP LH |
| D0500290 | 504020189,41221015 | HEAD LAMP ELEC/MAN, RH H7/H7/W5W/ |
| D0500583 | 504020193,41221036 | HEAD LAMP ELEC/MAN, LH H7/H7/W5W/ |
| D0600243 | 504047573,504047579 | CORNER LAMP PY21W |
| D0500584 | 504052352 | FOG LAMP RH H1 |
| D0500585 | 504052353 | FOG LAMP LH H1 |
| D0500592 | 504043819 | UPPER STEP PLATE RH=LH |
| D0500591 | 504043817 | LOWER STEP PLATE R=L |
| D0500593 | 504215019,504052936 | OUTSIDE HANDLE SET, 2 CYLS + 4KEYS |
| DI2.0220 | 504052936R | OUTSIDE HANDLE W/KEY RH (1 CYLINDER 2 KEYS) |
| DC0.2026 | 504052936L | OUTSIDE HANDLE W/KEY LH (1 CYLINDER 2 KEYS) |
| D0500359 | 99487780,2997195 | ELECTRICAL WINDOW REGULATOR RH W/O MOTOR |
| DC0.0995 | 99487781,2997196 | ELECTRICAL WINDOW REGULATOR RH W/O MOTOR |
| DC2.3149 | 504001931 | REFLECTOR |
| D0600063 | 2992664 | KEY CYLINDER (1 CYLINDER 2 KEYS) |
| D0600174 | 98474429 | BATTERY COVER |
| D0500590 | 504059310,504054940 | FR MUDGUARD RH FOR LOWERED WHEELS, WITH WING |
| D0500589 | 504054941 | FR MUDGUARD LH FOR LOWERED WHEELS, WITH WING |
| D0500290 | 504020189 | HEAD LAMP RH MANUAL H7/H7/W5W/ |
| D0500291 | 504020193 | HEAD LAMP LH MANUAL H7/H7/W5W/ |

| DIESSA REF. | O.E.M. REF. | DESCRIPTION |
|-------------|-------------|-----------------------------------------|
| DI2.0858 | 504238203 | HEAD LAMP RH ELECTRIC CHROME H7/H7/W5W/ |
| DI2.0859 | 504238213 | HEAD LAMP LH ELECTRIC CHROME H7/H7/W5W/ |

TECTOR 2006 -->

| | | |
|----------|---------------------------------|------------------------------------------------------------------------------------------------------------------------------------------------------|
| DI2.0862 | 504150552,504369995, 5801341207 | COMPLETE MIRROR RH CLASS II+ CLASS IV, MAIN MIRROR H ELECTRIC CLASS II, WIDE ANGLE MIRROR ELECTRIC CLASS IV , HEATED BLACK LONG ARM, R1200 +R300 LHD |
| DI2.0861 | 504150551,504369979, 5801341206 | COMPLETE MIRROR LH CLASS II+ CLASS IV, MAIN MIRROR H ELECTRIC CLASS II, WIDE ANGLE MIRROR ELECTRIC CLASS IV , HEATED BLACK LONG ARM, R1200 +R300 LHD |
| DI2.0055 | 504197879,2997668 | MIRROR GLASS CLASS IV WIDE ANGLE RH=LH HEATED R300 LHD |
| DI2.0054 | 504197878,504159282, 504159284 | MIRROR GLASS CLASS II RH=LH HEATED R1200 LHD |

IV STRALIS AS 2008->



DI2.0786



DC0.2012



DIO.0017



DIO.0016

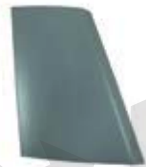

DI2.0670

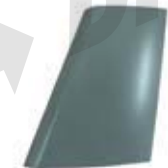

DI2.0671



D0500349



D0500350



DI2.0668



DI2.0669



DI2.0666



DI2.0072CZ



DC0.2031



DC0.2032



DI2.0667



DC0.2033



DI2.0879



DC0.2034

The parts referenced in this catalog are not original, but are perfectly adaptable to the models to which they are intended. The use of the manufacturers' marks and the original references is done exclusively for the purpose of indicating the model to which each piece is destined.

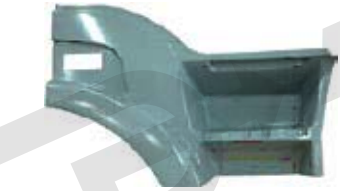

DC0.1576



DC0.1577



DI2.0849



DI2.0850



DC0.0856



DI2.0025



DC0.0857



810 mm



DI2.0064BL

DI2.0676



560 mm

DI2.0090



DI2.0065BL



DI2.0064

DI2.0066



DI2.0066BL



DI2.0065



The parts referenced in this catalog are not original, but are perfectly adaptable to the models to which they are intended.
The use of the manufacturers' marks and the original references is done exclusively for the purpose of indicating the model to which each piece is destined.

IV STRALIS AS 2008->



DI2.0672

DI2.0673

DI2.0674

DI2.0675

DI2.0776

DI2.0777

DC2.2886

DC2.2887

D0500331

D0500330

DC2.3149

D0500582

D0500290 (manual)

D0500583

D0500291 (manual)

D12.0858 (electric chrome)

D12.0859 (electric chrome)

D12.0030

D12.0031

D12.0452

D12.0451

D10.0004

D0500477

D0500478

D10.0005

The parts referenced in this catalog are not original, but are perfectly adaptable to the models to which they are intended. The use of the manufacturers' marks and the original references is done exclusively for the purpose of indicating the model to which each piece is destined.

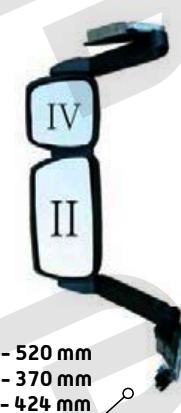
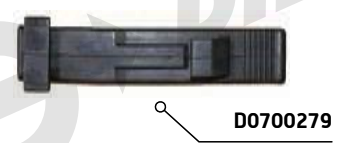
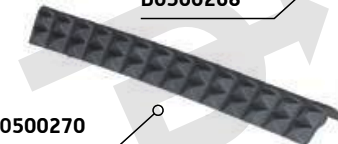
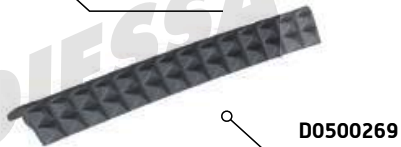
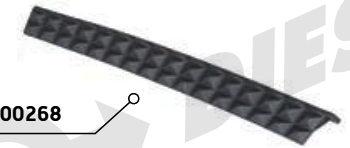
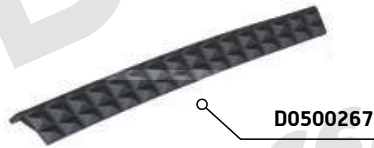

The parts referenced in this catalog are not original, but are perfectly adaptable to the models to which they are intended. The use of the manufacturers' marks and the original references is done exclusively for the purpose of indicating the model to which each piece is destined.

IV STRALIS AS 2008->



| DIESSA REF. | O.E.M. REF. | DESCRIPTION |
|-------------|---------------------------------|-------------------------------------------------------|
| DI2.0072CZ | 504284315,504186929 | FR BUMPER (WHITE CORNER PRIMED) |
| DI2.0879 | 504287143,504186928 | FR BUMPER WITH HEADLAMP WIPER HOLES - BLACK EXTENSION |
| DI2.0025 | 504170848,504170809 | FRONT GRILLE |
| DI2.0676 | 504194669 | UPPER STEP ON BUMPER |
| DI2.0090 | 504135514 | LOWER STEP ON BUMPER |
| DC0.2031 | 41218984 | "SIDE LIGHT HOLDER RH DARK GREY" |
| DC0.2032 | 41218983 | "SIDE LIGHT HOLDER LH DARK GREY" |
| DC0.2033 | 41213720 | CAP ON MUDGUARD RH |
| DC0.2034 | 41213721 | CAP ON MUDGUARD LH |
| DI2.0786 | 504156595,504065981 | LOWER FRAME, RH |
| DC0.2012 | 504156594,504065980 | LOWER FRAME, LH |
| DIO.0017 | 504008290 | COVER RH, SIDE BUMPER |
| DIO.0016 | 504194533,504008291 | COVER LH, SIDE BUMPER |
| DI2.0670 | 504187506 | BUMPER LID, RH |
| DI2.0671 | 504187507 | BUMPER LID, LH |
| DI2.0668 | 504187426 | BUMPER LID, RH |
| DI2.0669 | 504187427 | BUMPER LID, LH |
| DI2.0666 | 504187294 | BUMPER LID, RH |
| DI2.0667 | 504187339 | BUMPER LID, LH |
| DI2.0064 | 504190699, 504190780 | LOWER BUMPER SPOILER RH |
| DI2.0064BL | 504190780BL, 504190699BL | LOWER BUMPER SPOILER RH. LOWER BLACK PART |
| DI2.0065 | 504190700,504190781 | LOWER BUMPER SPOILER LH |
| DI2.0065BL | 504190700BL,504190781BL | LOWER BUMPER SPOILER LH. LOWER BLACK PART |
| DI2.0066 | 504190747, 504190697 | CENTRAL LOWER BUMPER SPOILER |
| DI2.0066BL | 504190747BL, 504190697BL | CENTRAL LOWER BUMPER SPOILER. LOWER BLACK PART |
| D0500349 | 504036807,504096162 | AIR DEFLECTOR (AS), RH |
| D0500350 | 504096163,504036808 | AIR DEFLECTOR (AS), LH |
| DC0.1576 | 504103308,500375667, 5801840545 | FRONT FENDER W/ HOLE, RH (AS) |
| DC0.1577 | 504103305,500375472, 504081139 | FRONT FENDER W/ HOLE, LH (AS) |
| DIO.0004 | 42555041,504187906, 5801755123 | CORNER LAMP RH |

| DIESSA REF. | O.E.M. REF. | DESCRIPTION |
|-------------|--------------------------------|-------------------------------------------------------------------|
| DIO.0005 | 42555042,5801755124 | CORNER LAMP LH |
| D0500582 | 504020189,41221015 | HEAD LAMP ELEC/MAN, RH H7/H7/W5W/ |
| D0500583 | 504020193,41221036 | HEAD LAMP ELEC/MAN, LH H7/H7/W5W/ |
| DI2.0030 | 500314717 | SUN VISOR'S MARKER RH BLACK |
| DI2.0031 | 500314716 | SUN VISOR'S MARKER LH BLACK |
| DI2.0452 | 98461649 | SUN VISOR'S MARKER RH SILVER |
| DI2.0451 | 98461648 | SUN VISOR'S MARKER LH SILVER |
| D0500331 | 41221039,504250984 | SIDE LAMP RH P21W |
| D0500330 | 41221029,504250958 | SIDE LAMP LH P21W |
| DIO.0004 | 42555041,504187906 | FRONT CORNER LAMP RH P21W |
| DIO.0005 | 42555042,5801755124, 504187902 | FRONT CORNER LAMP LH P21W |
| D0500478 | 37650000,99463242 | TAIL LAMP RH W/ LICENSE LAMP R5W/P21W/P21W/R5W/R5W/P21W/P21W/R10W |
| D0500477 | 504094715,99463244 | TAIL LAMP LH W/ LICENSE LAMP R5W/P21W/P21W/R5W/R5W/P21W/P21W/R10W |
| DI2.0672 | 504173478 | FOG LAMP HOUSING SUPPORT, RH |
| DI2.0673 | 50417347700;504173477 | FOG LAMP HOUSING SUPPORT, LH |
| DI2.0674 | 504188129 | FOG LAMP HOUSING W/HOLE, RH |
| DI2.0675 | 504188130 | FOG LAMP HOUSING W/HOLE, LH |
| DI2.0776 | 504187939 | FOG LAMP HOUSING W/O HOLE, RH |
| DI2.0777 | 504187940 | FOG LAMP HOUSING W/O HOLE, LH |
| DC2.2886 | 5801584081 | FR/LAMP HSG W/HOLE, CHROME, RH |
| DC2.2887 | 5801584082 | FR/LAMP HSG W/HOLE, CHROME, LH |
| D0500593 | 504215019,504052936 | OUTSIDE HANDLE SET, 2 CYLS + 4KEYS |
| DI2.0220 | 504052936R | OUTSIDE HANDLE W/KEY RH (1 CYLINDER 2 KEYS) |
| DC0.2026 | 504052936L | OUTSIDE HANDLE W/KEY LH (1 CYLINDER 2 KEYS) |
| DI2.0039 | 98472610 | INSIDE DOOR HANDLE RH=LH |
| DC2.3149 | 504001931 | REFLECTOR |
| D0600063 | 2992664 | KEY CYLINDER (1 CYLINDER 2 KEYS) |
| D0500359 | 99487780,2997195 | ELECTRICAL WINDOW REGULATOR RH W/O MOTOR |
| DC0.0995 | 99487781,2997196 | ELECTRICAL WINDOW REGULATOR RH W/O MOTOR |
| DC0.0856 | 500375431,504103304, 2997119 | FOOTBOARD (BLACK), RH |

| DIESSA REF. | O.E.M. REF. | DESCRIPTION |
|-------------|--------------------------------|-----------------------------------------------------------------------------------------------------------------------------------------------------|
| DC0.0857 | 500375430,504103303,2997118 | FOOTBOARD (BLACK), LH |
| DI2.0849 | 504215973,504083111,2997579 | FOOTBOARD (LIGHT GREY), RH |
| DI2.0850 | 504215971,504083110,2997578 | FOOTBOARD (LIGHT GREY), LH |
| D0700070 | 41213750,41213691,41298975 | TOP MUDGUARD RH/LH |
| DI2.0857 | 41213751,41298976,41213692 | TOP MUDGUARD RH/LH FLAT TYPE |
| D0700285 | 41213754,41299389,41299388 | REAR HALF MUDGUARD RH/LH LONG |
| D0700279 | 41213696,2997670 | RUBER STRAPE |
| D0500267 | 504001361 | UPPER EXTENSION, FOOTBOARD, RH |
| D0500268 | 504001358 | UPPER EXTENSION, FOOTBOARD, LH |
| D0500269 | 504001345 | LOWER EXTENSION, FOOTBOARD, RH |
| D0500270 | 504001344 | LOWER EXTENSION, FOOTBOARD, LH |
| DC0.2038 | 41213729 | MUDGUARD SUPPORT LH |
| DC0.2037 | 41213731 | MUDGUARD SUPPORT RH |
| DC0.2036 | 41213725 | MUDGUARD SUPPORT LH |
| DC0.2035 | 41213727 | MUDGUARD SUPPORT RH |
| D0600174 | 98474429 | BATTERY COVER |
| DI2.0862 | 504150552,504369995,5801341207 | COMPLETE MIRROR RH CLASS II+ CLASS IV, MAIN MIRROR H ELECTRIC CLASS II, WIDE ANGLE MIRROR ELECTRIC CLASS IV, HEATED BLACK LONG ARM, R1200 +R300 LHD |
| DI2.0861 | 504150551,504369979,5801341206 | COMPLETE MIRROR LH CLASS II+ CLASS IV, MAIN MIRROR H ELECTRIC CLASS II, WIDE ANGLE MIRROR ELECTRIC CLASS IV, HEATED BLACK LONG ARM, R1200 +R300 LHD |
| DI2.0061 | 504150526,504369910,5801334614 | COMPLETE MIRROR LH CLASS II+ CLASS IV, MAIN MIRROR ELECTRIC CLASS II, WIDE ANGLE MIRROR ELECTRIC CLASS IV, HEATED BLACK SHORT ARM, R1200 +R300 LHD |
| DI2.0062 | 504150527,504369961,5801334610 | COMPLETE MIRROR RH CLASS II+ CLASS IV, MAIN MIRROR ELECTRIC CLASS II, WIDE ANGLE MIRROR ELECTRIC CLASS IV, HEATED BLACK SHORT ARM, R1200 +R300 LHD |
| DI2.0871 | 504150538,504370048,5801336285 | COMPLETE MIRROR LH CLASS II+ CLASS IV, MAIN MIRROR ELECTRIC CLASS II, WIDE ANGLE MIRROR ELECTRIC CLASS IV, HEATED BLACK MEDIUM ARM, R1200 +R300 LHD |
| DI2.0872 | 504150539,504370055,5801336298 | COMPLETE MIRROR RH CLASS II+ CLASS IV, MAIN MIRROR ELECTRIC CLASS II, WIDE ANGLE MIRROR ELECTRIC CLASS IV, HEATED BLACK MEDIUM ARM, R1200 +R300 LHD |
| DI2.0055 | 504197879,2997668 | MIRROR GLASS CLASS IV WIDE ANGLE RH=LH HEATED R300 LHD |

| DIESSA REF. | O.E.M. REF. | DESCRIPTION |
|-------------|-------------------------------|-------------------------------------------------|
| DI2.0054 | 504197878,504159282,504159284 | MIRROR GLASS CLASS II RH=LH HEATED R1200 LHD |
| DI2.0809 | 504168236 | MIRROR ROOF CLASS V RH MANUAL HEATED R300 LHD |
| DI2.0810 | 504224428 | FRONT MIRROR CLASS VI RH MANUAL HEATED R300 LHD |
| D0500290 | 504020189 | HEAD LAMP RH MANUAL H7/H7/W5W/ |
| D0500291 | 504020193 | HEAD LAMP LH MANUAL H7/H7/W5W/ |
| DI2.0858 | 504238203 | HEAD LAMP RH ELECTRIC CHROME H7/H7/W5W/ |
| DI2.0859 | 504238213 | HEAD LAMP LH ELECTRIC CHROME H7/H7/W5W/ |

IV STRALIS AD/AT 2008->



DI2.0786



DI2.0670



DCO.2012



DI2.0671



DI2.0668



D0500257

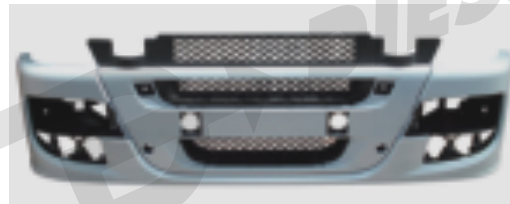

DI2.0069CZ



D0500258



DI2.0669



DI2.0666



DCO.2031



810 mm

DI2.0676



DCO.2032



DI2.0667



DCO.2033



DI2.0090

560 mm



DCO.2034

The parts referenced in this catalog are not original, but are perfectly adaptable to the models to which they are intended. The use of the manufacturers' marks and the original references is done exclusively for the purpose of indicating the model to which each piece is destined.

IV STRALIS AD/AT 2008->

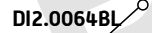
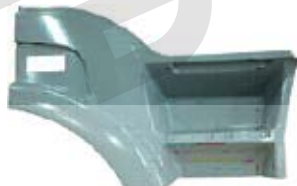
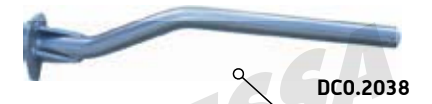
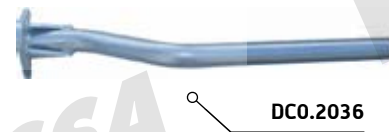
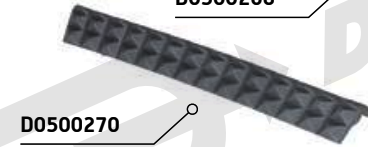
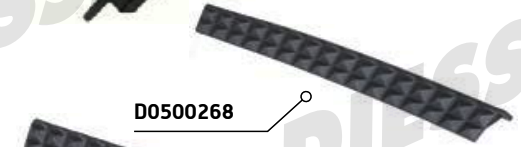

The parts referenced in this catalog are not original, but are perfectly adaptable to the models to which they are intended. The use of the manufacturers' marks and the original references is done exclusively for the purpose of indicating the model to which each piece is destined.

IV STRALIS AD/AT 2008->



DI2.0672



DI2.0674



DI2.0776



DC2.2886



DC2.2999



DI2.0030



DI2.0452



DIO.0004



D0500330



DC2.3149



D0500331



D0500582

D0500290
(manual)

DI2.0858
(electric chrome)



D0500583

D0500291
(manual)

DI2.0859
(electric chrome)



D0500477



D0500478



DIO.0005



DI2.0673



DI2.0675



DI2.0777



DC2.2887



DC2.3000



DI2.0031



DI2.0451

The parts referenced in this catalog are not original, but are perfectly adaptable to the models to which they are intended. The use of the manufacturers' marks and the original references is done exclusively for the purpose of indicating the model to which each piece is destined.

IV STRALIS AD/AT 2008->



DI2.0862 - 520 mm
DI2.0062 - 370 mm
DI2.0872 - 424 mm



DI2.0055



DI2.0054



DI2.0861 - 520 mm
DI2.0061 - 370 mm
DI2.0871 - 424 mm



D0600063



DI2.0809



DI2.0810



D0500593



DI2.0220



DI2.0039

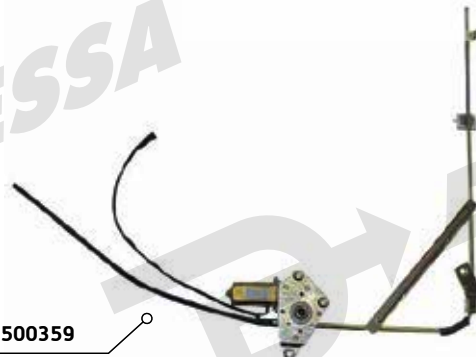

D0500359



DC0.0995



DC0.2026

The parts referenced in this catalog are not original, but are perfectly adaptable to the models to which they are intended.
The use of the manufacturers' marks and the original references is done exclusively for the purpose of indicating the model to which each piece is destined.

IV STRALIS AD/AT 2008->



| DIESSA REF. | O.E.M. REF. | DESCRIPTION |
|-------------|---------------------------------|------------------------------------------------|
| DI2.0069CZ | 504284316,504186932 | FR BUMPER |
| DI2.0676 | 504194669 | UPPER STEP ON BUMPER |
| DI2.0090 | 504135514 | LOWER STEP ON BUMPER |
| DC0.2031 | 41218984 | SIDE LIGHT HOLDER RH DARK GREY |
| DC0.2032 | 41218983 | SIDE LIGHT HOLDER LH DARK GREY |
| DC0.2033 | 41213720 | CAP ON MUDGUARD RH |
| DC0.2034 | 41213721 | CAP ON MUDGUARD LH |
| D0500257 | 504056033 | AIR DEFLECTOR RH |
| D0500258 | 504056034,504203478 | AIR DEFLECTOR LH |
| DI2.0786 | 504156595,504065981 | LOWER FRAME, RH |
| DC0.2012 | 504156594,504065980 | LOWER FRAME, LH |
| DI2.0670 | 504187506 | BUMPER LID, RH |
| DI2.0671 | 504187507 | BUMPER LID, LH |
| DI2.0668 | 504187426 | BUMPER LID, RH |
| DI2.0669 | 504187427 | BUMPER LID, LH |
| DI2.0666 | 504187294 | BUMPER LID, RH |
| DI2.0667 | 504187339 | BUMPER LID, LH |
| DI2.0064 | 504190699, 504190780 | LOWER BUMPER SPOILER RH |
| DI2.0064BL | 504190780BL, 504190699BL | LOWER BUMPER SPOILER RH. LOWER BLACK PART |
| DI2.0065 | 504190700,504190781 | LOWER BUMPER SPOILER LH |
| DI2.0065BL | 504190700BL,504190781BL | LOWER BUMPER SPOILER LH. LOWER BLACK PART |
| DI2.0066 | 504190747, 504190697 | CENTRAL LOWER BUMPER SPOILER |
| DI2.0066BL | 504190747BL, 504190697BL | CENTRAL LOWER BUMPER SPOILER. LOWER BLACK PART |
| DC0.1576 | 504103308,500375667, 5801840545 | FRONT FENDER W/ HOLE, RH (AS) |
| DC0.1577 | 504103305,500375472, 504081139 | FRONT FENDER W/ HOLE, LH (AS) |
| DI0.0004 | 42555041,504187906, 425550041 | CORNER LAMP RH |
| DI0.0005 | 42555042,5801755124 | CORNER LAMP LH |
| D0500582 | 504020189,41221015 | HEAD LAMP ELEC/MAN, RH H7/H7/W5W/ |
| D0500583 | 504020193,41221036 | HEAD LAMP ELEC/MAN, LH H7/H7/W5W/ |
| DI2.0030 | 500314717 | SUN VISOR'S MARKER RH BLACK |
| DI2.0031 | 500314716 | SUN VISOR'S MARKER LH BLACK |

| DIESSA REF. | O.E.M. REF. | DESCRIPTION |
|-------------|--------------------------------|--------------------------------------------------------------------|
| DI2.0452 | 98461649 | SUN VISOR'S MARKER RH SILVER |
| DI2.0451 | 98461648 | SUN VISOR'S MARKER LH SILVER |
| D0500331 | 41221039,504250984 | SIDE LAMP RH P21W |
| D0500330 | 41221029,504250958 | SIDE LAMP LH P21W |
| DI0.0004 | 42555041,504187906, | FRONT CORNER LAMP RH P21W |
| DI0.0005 | 42555042,5801755124, 504187902 | FRONT CORNER LAMP LH P21W |
| D0500478 | 37650000,99463242 | TAIL LAMP RH W/ LICENSE LAMP R5W/P21W/P21W/R5W/R5W/P21W/P21W/ R10W |
| D0500477 | 504094715,99463244 | TAIL LAMP LH W/ LICENSE LAMP R5W/P21W/P21W/R5W/R5W/P21W/P21W/ R10W |
| DI2.0672 | 504173478 | FOG LAMP HOUSING SUPPORT, RH |
| DI2.0673 | 50417347700;504173477 | FOG LAMP HOUSING SUPPORT, LH |
| DI2.0674 | 504188129 | FOG LAMP HOUSING W/HOLE, RH |
| DI2.0675 | 504188130 | FOG LAMP HOUSING W/HOLE, LH |
| DI2.0776 | 504187939 | FOG LAMP HOUSING W/O HOLE, RH |
| DI2.0777 | 504187940 | FOG LAMP HOUSING W/O HOLE, LH |
| DC2.2999 | 504135530 | FOG LAMP HOUSING W/HOLE, RH |
| DC2.3000 | 504135532 | FOG LAMP HOUSING W/HOLE, LH |
| DC2.2886 | 5801584081 | FR/LAMP HSG W/HOLE, CHROME, RH |
| DC2.2887 | 5801584082 | FR/LAMP HSG W/HOLE, CHROME, LH |
| D0500593 | 504215019,504052936 | OUTSIDE HANDLE SET, 2 CYLS + 4KEYS |
| DI2.0220 | 504052936R | OUTSIDE HANDLE W/KEY RH (1 CYLINDER 2 KEYS) |
| DC0.2026 | 504052936L | OUTSIDE HANDLE W/KEY LH (1 CYLINDER 2 KEYS) |
| DI2.0039 | 98472610 | INSIDE DOOR HANDLE RH=LH |
| DC2.3149 | 504001931 | REFLECTOR |
| D0600063 | 2992664 | KEY CYLINDER (1 CYLINDER 2 KEYS) |
| D0500359 | 99487780,2997195 | ELECTRICAL WINDOW REGULATOR RH W/O MOTOR |
| DC0.0995 | 99487781,2997196 | ELECTRICAL WINDOW REGULATOR RH W/O MOTOR |
| DC0.0856 | 500375431, /504103304, 2997119 | FOOTBOARD (BLACK), RH |
| DC0.0857 | 500375430,504103303, 2997118 | FOOTBOARD (BLACK), LH |
| DI2.0849 | 504215973,504083111, 2997579 | |

| DIESSA REF. | O.E.M. REF. | DESCRIPTION |
|-------------|--------------------------------|-----------------------------------------------------------------------------------------------------------------------------------------------------|
| DI2.0850 | 504215971,504083110,2997578 | FOOTBOARD (LIGHT GREY), RH |
| D0700070 | 41213750,41213691,41298975 | FOOTBOARD (LIGHT GREY), LH |
| DI2.0857 | 41213751,41298976 | TOP MUDGUARD RH/LH |
| D0700285 | 41213754 | TOP MUDGUARD RH/LH FLAT TYPE |
| D0700279 | 41213696,2997670 | "REAR HALF MUDGUARD RH/LH LONG" |
| D0500267 | 504001361 | RUBER STRAPE |
| D0500268 | 504001358 | UPPER EXTENSION, FOOTBOARD, RH |
| D0500269 | 504001345 | UPPER EXTENSION, FOOTBOARD, LH |
| D0500270 | 504001344 | LOWER EXTENSION, FOOTBOARD, RH |
| DC0.2038 | 41213729 | LOWER EXTENSION, FOOTBOARD, LH |
| DC0.2037 | 41213731 | MUDGUARD SUPPORT LH |
| DC0.2036 | 41213725 | MUDGUARD SUPPORT RH |
| DC0.2035 | 41213727 | MUDGUARD SUPPORT LH |
| D0600174 | 98474429,4858294 | MUDGUARD SUPPORT RH |
| DI2.0862 | 504150552,504369995,5801341207 | COMPLETE MIRROR RH CLASS II+ CLASS IV, MAIN MIRROR H ELECTRIC CLASS II, WIDE ANGLE MIRROR ELECTRIC CLASS IV, HEATED BLACK LONG ARM, R1200 +R300 LHD |
| DI2.0861 | 504150551,504369979,5801341206 | COMPLETE MIRROR LH CLASS II+ CLASS IV, MAIN MIRROR H ELECTRIC CLASS II, WIDE ANGLE MIRROR ELECTRIC CLASS IV, HEATED BLACK LONG ARM, R1200 +R300 LHD |
| DI2.0061 | 504150526,504369910,5801334614 | COMPLETE MIRROR LH CLASS II+ CLASS IV, MAIN MIRROR H ELECTRIC CLASS II, WIDE ANGLE MIRROR ELECTRIC CLASS IV, HEATED BLACK LONG ARM, R1200 +R300 LHD |
| DI2.0062 | 504150527,504369961,5801334610 | COMPLETE MIRROR RH CLASS II+ CLASS IV, MAIN MIRROR ELECTRIC CLASS II, WIDE ANGLE MIRROR ELECTRIC CLASS IV, HEATED BLACK SHORT ARM, R1200 +R300 LHD |
| DI2.0871 | 504150538,504370048,5801336285 | COMPLETE MIRROR LH CLASS II+ CLASS IV, MAIN MIRROR ELECTRIC CLASS II, WIDE ANGLE MIRROR ELECTRIC CLASS IV, HEATED BLACK SHORT ARM, R1200 +R300 LHD |
| DI2.0872 | 504150539,504370055,5801336298 | COMPLETE MIRROR RH CLASS II+ CLASS IV, MAIN MIRROR ELECTRIC CLASS II, WIDE ANGLE MIRROR ELECTRIC CLASS IV, HEATED BLACK MEDIUM ARM, R1200 +R300 LHD |
| DI2.0055 | 504197879,2997668,0 | COMPLETE MIRROR LH CLASS II+ CLASS IV, MAIN MIRROR ELECTRIC CLASS II, WIDE ANGLE MIRROR ELECTRIC CLASS IV, HEATED BLACK MEDIUM ARM, R1200 +R300 LHD |
| DI2.0054 | 504197878,504159282,504159284 | MIRROR GLASS CLASS IV WIDE ANGLE RH=LH HEATED R300 LHD |
| DI2.0809 | 504168236 | MIRROR GLASS CLASS II RH=LH HEATED R1200 LHD |

| DIESSA REF. | O.E.M. REF. | DESCRIPTION |
|-------------|-------------|-----------------------------------------------|
| DI2.0810 | 504224428 | MIRROR ROOF CLASS V RH MANUAL HEATED R300 LHD |
| D0500290 | 504020189 | HEAD LAMP RH MANUAL H7/H7/W5W/ |
| D0500291 | 504020193 | HEAD LAMP LH MANUAL H7/H7/W5W/ |
| DI2.0858 | 504238203 | HEAD LAMP RH ELECTRIC CHROME H7/H7/W5W/ |
| DI2.0859 | 504238213 | HEAD LAMP LH ELECTRIC CHROME H7/H7/W5W/ |

IV EUROCARGO 2008

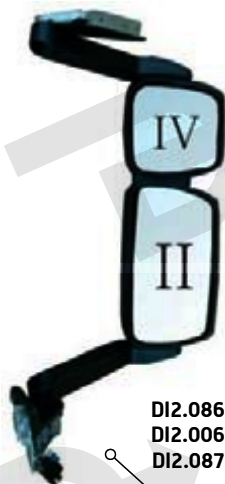

DI2.0862 - 520 mm
DI2.0062 - 370 mm
DI2.0872 - 424 mm



DI2.0055



DI2.0054

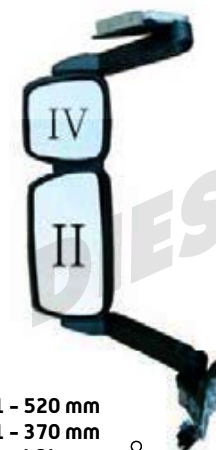

DI2.0861 - 520 mm
DI2.0061 - 370 mm
DI2.0871 - 424 mm



DC2.3152



DC2.3153



D0600248



DI2.0916



DC2.3154



DI2.0810



D0600249



D0500359



DC2.2997



DI2.0911



DI2.0912



DC0.0995

The parts referenced in this catalog are not original, but are perfectly adaptable to the models to which they are intended. The use of the manufacturers' marks and the original references is done exclusively for the purpose of indicating the model to which each piece is destined.

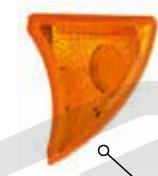

The parts referenced in this catalog are not original, but are perfectly adaptable to the models to which they are intended. The use of the manufacturers' marks and the original references is done exclusively for the purpose of indicating the model to which each piece is destined.

| DIESSA REF. | O.E.M. REF. | DESCRIPTION |
|-------------|---------------------------------|-----------------------------------------------------------------------------------------------------------------------------------------------------|
| DC2.3152 | 504281899 | FR BUMPER W/O FOGLAMP HOLES - 620 MM HEIGHT |
| DC2.3153 | 504281900,504281901 | FR BUMPER W/FOGLAMP HOLES - 620 MM HEIGHT |
| DI2.0916 | 504281893 | FR BUMPER W/O FOGLAMP HOLES - 560 MM HEIGHT |
| DC2.3154 | 504281894 | FR BUMPER W/FOGLAMP HOLES - 560 MM HEIGHT |
| DC2.2997 | 504281895,5801844153 | BUMPER W/FOG LAMPS HOLES, W/HESDLIGHT WASHER HOLES 560 mm HEIGHT |
| DI2.0911 | 504281887,5801797763,5801797825 | FR BUMPER W/O FOGLAMP HOLES - 380 MM HEIGHT |
| DI2.0912 | 504281889,5801797764,504281888 | FR BUMPER W/FOGLAMP HOLES - 380 MM HEIGHT |
| DC2.3136 | 504258217 | FRONT GRILLE |
| D0600248 | 504116074,504129976,504060280 | AIR DEFLECTOR LH |
| D0600249 | 504116073,504129977,504060281 | AIR DEFLECTOR LH |
| DI2.0676 | 504194669 | UPPER STEP ON BUMPER |
| DI2.0090 | 504135514 | LOWER STEP ON BUMPER |
| D0600245 | 504037737,504058446,504299045 | FOOTSTEP MUDGUARD LH |
| D0600244 | 504037735,504058445 | FOOTSTEP MUDGUARD RH |
| D0500359 | 99487780,2997195 | ELECTRICAL WINDOW REGULATOR RH W/O MOTOR |
| DC0.0995 | 99487781,2997196 | ELECTRICAL WINDOW REGULATOR RH W/O MOTOR |
| DIO.0015 | 504020189,41221015 | HEAD LAMP ELEC/MAN, RH H7/H7/W5W/ |
| DIO.0025 | 504020193,41221036 | HEAD LAMP ELEC/MAN, LH H7/H7/W5W/ |
| DI2.0030 | 500314717 | SUN VISOR'S MARKER RH BLACK |
| DI2.0031 | 500314716 | SUN VISOR'S MARKER LH BLACK |
| DI2.0452 | 98461649 | SUN VISOR'S MARKER RH SILVER |
| DI2.0451 | 98461648 | SUN VISOR'S MARKER LH SILVER |
| D0500478 | 99463242,504094705 | TAIL LAMP RH W/O LICENSE LAMP R5W/P21W/P21W/R5W/R5W/P21W/P21W/R10W |
| DIO.0004 | 42555041,504187906 | FRONT CORNER LAMP RH P21W |
| DIO.0005 | 42555042,5801755124,504187902 | FRONT CORNER LAMP LH P21W |
| DI2.0862 | 504150552,504369995,5801341207 | COMPLETE MIRROR RH CLASS II+ CLASS IV, MAIN MIRROR H ELECTRIC CLASS II, WIDE ANGLE MIRROR ELECTRIC CLASS IV, HEATED BLACK LONG ARM, R1200 +R300 LHD |

| DIESSA REF. | O.E.M. REF. | DESCRIPTION |
|-------------|--------------------------------|-----------------------------------------------------------------------------------------------------------------------------------------------------|
| DI2.0861 | 504150551,504369979,5801341206 | COMPLETE MIRROR LH CLASS II+ CLASS IV, MAIN MIRROR H ELECTRIC CLASS II, WIDE ANGLE MIRROR ELECTRIC CLASS IV, HEATED BLACK LONG ARM, R1200 +R300 LHD |
| DI2.0061 | 504150526,504369910,5801334614 | COMPLETE MIRROR LH CLASS II+ CLASS IV, MAIN MIRROR ELECTRIC CLASS II, WIDE ANGLE MIRROR ELECTRIC CLASS IV, HEATED BLACK SHORT ARM, R1200 +R300 LHD |
| DI2.0062 | 504150527,504369961,5801334610 | COMPLETE MIRROR RH CLASS II+ CLASS IV, MAIN MIRROR ELECTRIC CLASS II, WIDE ANGLE MIRROR ELECTRIC CLASS IV, HEATED BLACK SHORT ARM, R1200 +R300 LHD |
| DI2.0871 | 504150538,504370048,5801336285 | COMPLETE MIRROR LH CLASS II+ CLASS IV, MAIN MIRROR ELECTRIC CLASS II, WIDE ANGLE MIRROR ELECTRIC CLASS IV, HEATED BLACK MEDIUM ARM, R1200 +R300 LHD |
| DI2.0872 | 504150539,504370055,5801336298 | COMPLETE MIRROR RH CLASS II+ CLASS IV, MAIN MIRROR ELECTRIC CLASS II, WIDE ANGLE MIRROR ELECTRIC CLASS IV, HEATED BLACK MEDIUM ARM, R1200 +R300 LHD |
| DI2.0055 | 504197879,2997668 | MIRROR GLASS CLASS IV WIDE ANGLE RH=LH HEATED R300 LHD |
| DI2.0054 | 504197878,504159282,504159284 | MIRROR GLASS CLASS II RH=LH HEATED R1200 LHD |
| DI2.0809 | 504168236 | MIRROR ROOF CLASS V RH MANUAL HEATED R300 LHD |
| DI2.0810 | 504224428 | FRONT MIRROR CLASS VI RH MANUAL HEATED R300 LHD |

IV AD/AT STRALIS 2013 HI-ROAD_EURO6



The parts referenced in this catalog are not original, but are perfectly adaptable to the models to which they are intended.
 The use of the manufacturers' marks and the original references is done exclusively for the purpose of indicating the model to which each piece is destined.

IV AD/AT STRALIS 2013 HI-ROAD_EURO6

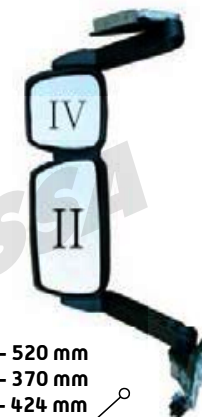
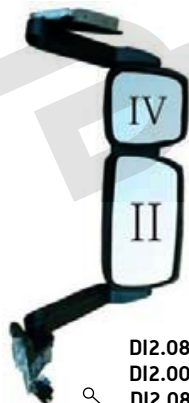
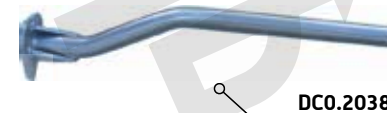

DC2.2478

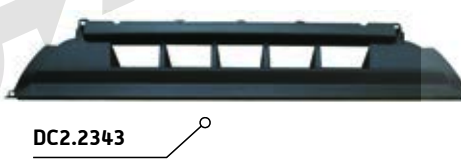
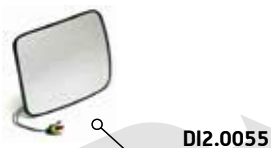
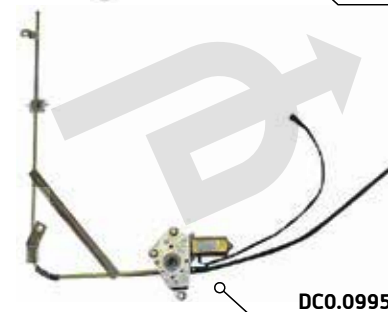
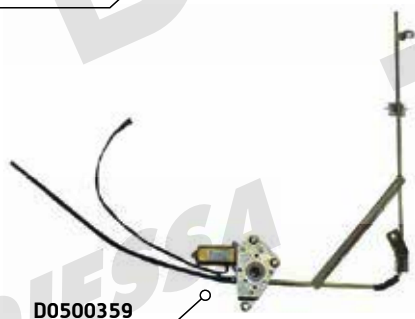

The parts referenced in this catalog are not original, but are perfectly adaptable to the models to which they are intended. The use of the manufacturers' marks and the original references is done exclusively for the purpose of indicating the model to which each piece is destined.



DI2.0776



DC2.2886



DC2.2887



DI2.0777



DC2.2999



DC2.2999CR



DC2.2891



DC2.3000CR



DC2.3000



DC2.3480



DC2.3481

The parts referenced in this catalog are not original, but are perfectly adaptable to the models to which they are intended.
The use of the manufacturers' marks and the original references is done exclusively for the purpose of indicating the model to which each piece is destined.

IV AD/AT STRALIS 2013 HI-ROAD_EURO6



DI2.0672



DI2.0674



DI2.0675



DI2.0673



DI2.0030



DI2.0031



DI2.0452



DI2.0451



DC2.3008



DC2.3009



DC2.3288



DC2.3035



DC2.3545



DC2.3544



DIO.0004



DIO.0005



DI2.0858
(electric chrome)



DI2.0859
(electric chrome)



D0500582
D0500290
(manual)



D0500583
D0500291
(manual)



DI2.0788



DI2.0846



DI2.0788



DI2.0846



D0500478



D0500477



DI2.0864



DC2.2220

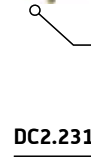

DC2.2316



DI2.0863

The parts referenced in this catalog are not original, but are perfectly adaptable to the models to which they are intended. The use of the manufacturers' marks and the original references is done exclusively for the purpose of indicating the model to which each piece is destined.

| DIESSA REF. | O.E.M. REF. | DESCRIPTION |
|-------------|---------------------------------------|-----------------------------------|
| DI2.0069CZ | 504284316,504186932 | FR BUMPER |
| DC2.2236CZ | 5801603586 | FR BUMPER (HI-WAY) |
| DI2.0676 | 504194669 | UPPER STEP ON BUMPER |
| DI2.0090 | 504135514 | LOWER STEP ON BUMPER |
| DC0.2033 | 41213720 | CAP ON MUDGUARD RH |
| DC0.2034 | 41213721 | CAP ON MUDGUARD LH |
| DC2.2888 | 5801564804, 5801564188 | AIR DEFLECTOR RH |
| DC2.2889 | 5801564805, 5801564189 | AIR DEFLECTOR LH |
| DI2.0670 | 504187506 | BUMPER LID, RH |
| DI2.0671 | 504187507 | BUMPER LID, LH |
| DI2.0668 | 504187426 | BUMPER LID, RH |
| DI2.0669 | 504187427 | BUMPER LID, LH |
| DI2.0666 | 504187294 | BUMPER LID, RH |
| DI2.0667 | 504187339 | BUMPER LID, LH |
| DC2.2343 | 5801562137 | CENTRAL LOWER BUMPER SPOILER |
| DC2.2282 | 5801562167 | LOWER BUMPER SPOILER RH |
| DC2.2283 | 5801562166 | LOWER BUMPER SPOILER LH |
| DI2.0846 | 504181096; 50418109600 | HIGH BEAM LAMP (INNER) RH=LH H1 |
| DI2.0788 | 504181095 | FOG LAMP, RH=LH H1 |
| D0500582 | 504020189,41221015 | HEAD LAMP ELEC/MAN, RH H7/H7/W5W/ |
| D0500583 | 504020193,41221036 | HEAD LAMP ELEC/MAN, LH H7/H7/W5W/ |
| DC2.3035 | 5801639118,5801745781, 5801745449" | HEAD LAMP ELEC/MAN, LH H7/H7/LED |
| DC2.3288 | 5801639122,5801745452 | HEAD LAMP ELEC/MAN, RH H7/H7/LED |
| DI2.0030 | 500314717 | SUN VISOR'S MARKER RH BLACK |
| DI2.0031 | 500314716 | SUN VISOR'S MARKER LH BLACK |
| DI2.0452 | 98461649 | SUN VISOR'S MARKER RH SILVER |
| DI2.0451 | 98461648 | SUN VISOR'S MARKER LH SILVER |
| DI2.0864 | 41221029,504250984, 504098245 | SIDE LAMP RH P21W |
| D0500330 | 41221029,504250958 | SIDE LAMP LH P21W |
| DC2.2220 | 5801572074,5801754885 | SIDE LAMP RH 3 HOLES P21W |

| DIESSA REF. | O.E.M. REF. | DESCRIPTION |
|-------------|-----------------------------------|------------------------------------------------------------------------|
| DC2.2316 | 5801572080,5801754886 | SIDE LAMP LH 3 HOLES P21W |
| DI0.0004 | 42555041,504187906 | FRONT CORNER LAMP RH P21W, ORANGE |
| DI0.0005 | 42555042,5801755124, 504187902 | FRONT CORNER LAMP LH P21W, ORANGE |
| D0500478 | 99463242,504094705 | TAIL LAMP RH W/O LICENSE LAMP R5W/P21W/P21W/R5W/R5W/P21W/ P21W/R10W |
| D0500477 | 99463244,99463243, 504094715 | TAIL LAMP LH W/O LICENSE LAMP R5W/P21W/P21W/R5W/R5W/P21W/ P21W/R10W |
| DI2.0672 | 504173478 | FOG LAMP HOUSING SUPPORT, RH |
| DI2.0673 | 50417347700;504173477 | FOG LAMP HOUSING SUPPORT, LH |
| DI2.0674 | 504188129 | FOG LAMP HOUSING W/HOLE, RH |
| DI2.0675 | 504188130 | FOG LAMP HOUSING W/HOLE, LH |
| DI2.0776 | 504187939 | FOG LAMP HOUSING W/O HOLE, RH |
| DI2.0777 | 504187940 | FOG LAMP HOUSING W/O HOLE, LH |
| DC2.2999 | 504135530 | FOG LAMP HOUSING W/HOLE, RH |
| DC2.3000 | 504135532 | FOG LAMP HOUSING W/HOLE, LH |
| DC2.2886 | 5801584081 | FR/LAMP HSG W/HOLE, CHROME, RH |
| DC2.2887 | 5801584082 | FR/LAMP HSG W/HOLE, CHROME, LH |
| D0500359 | 99487780,2997195 | ELECTRICAL WINDOW REGULATOR RH W/O MOTOR |
| DC0.0995 | 99487781,2997196 | ELECTRICAL WINDOW REGULATOR RH W/O MOTOR |
| D0500259 | 504103239,504047584 | FENDER, RH |
| D0500260 | 504103238,504047583, 504211274 | FENDER, LH |
| D0700070 | 41213750,41213691, 41298975 | TOP MUDGUARD RH/LH |
| DI2.0857 | 41213751,41298976, 41213692 | TOP MUDGUARD RH/LH FLAT TYPE |
| D0700285 | 41213754 | REAR HALF MUDGUARD RH/LH LONG |
| D0700279 | 41213696,2997670 | RUBBER STARP |
| DC0.2038 | 41213729 | MUDGUARD SUPPORT LH |
| DC0.2037 | 41213731 | MUDGUARD SUPPORT RH |
| DC0.2036 | 41213725 | MUDGUARD SUPPORT LH |
| DC0.2035 | 41213727 | MUDGUARD SUPPORT RH |
| D0600174 | 98474429 | BATTERY COVER |

| DIESSA REF. | O.E.M. REF. | DESCRIPTION |
|-------------|----------------------------------|-----------------------------------------------------------------------------------------------------------------------------------------------------|
| DI2.0862 | 504150552,504369995,5801341207 | COMPLETE MIRROR RH CLASS II+ CLASS IV, MAIN MIRROR H ELECTRIC CLASS II, WIDE ANGLE MIRROR ELECTRIC CLASS IV, HEATED BLACK LONG ARM, R1200 +R300 LHD |
| DI2.0861 | "504150551,504369979,5801341206" | COMPLETE MIRROR LH CLASS II+ CLASS IV, MAIN MIRROR H ELECTRIC CLASS II, WIDE ANGLE MIRROR ELECTRIC CLASS IV, HEATED BLACK LONG ARM, R1200 +R300 LHD |
| DI2.0061 | 504150526,504369910,5801334614 | COMPLETE MIRROR LH CLASS II+ CLASS IV, MAIN MIRROR ELECTRIC CLASS II, WIDE ANGLE MIRROR ELECTRIC CLASS IV, HEATED BLACK SHORT ARM, R1200 +R300 LHD |
| DI2.0062 | 504150527,504369961,5801334610 | COMPLETE MIRROR RH CLASS II+ CLASS IV, MAIN MIRROR ELECTRIC CLASS II, WIDE ANGLE MIRROR ELECTRIC CLASS IV, HEATED BLACK SHORT ARM, R1200 +R300 LHD |
| DI2.0871 | 504150538,504370048,5801336285 | COMPLETE MIRROR LH CLASS II+ CLASS IV, MAIN MIRROR ELECTRIC CLASS II, WIDE ANGLE MIRROR ELECTRIC CLASS IV, HEATED BLACK MEDIUM ARM, R1200 +R300 LHD |
| DI2.0872 | 504150539,504370055,5801336298 | COMPLETE MIRROR RH CLASS II+ CLASS IV, MAIN MIRROR ELECTRIC CLASS II, WIDE ANGLE MIRROR ELECTRIC CLASS IV, HEATED BLACK MEDIUM ARM, R1200 +R300 LHD |
| DI2.0055 | 504197879,2997668 | MIRROR GLASS CLASS IV WIDE ANGLE RH=LH HEATED R300 LHD |
| DI2.0054 | 504197878,504159282,504159284 | MIRROR GLASS CLASS II RH=LH HEATED R1200 LHD |
| DI2.0809 | 504168236 | MIRROR ROOF CLASS V RH MANUAL HEATED R300 LHD |
| DI2.0810 | 504224428 | FRONT MIRROR CLASS VI RH MANUAL HEATED R300 LHD |
| D0500290 | 504020189 | HEAD LAMP RH MANUAL H7/H7/W5W/ |
| D0500291 | 504020193 | HEAD LAMP LH MANUAL H7/H7/W5W/ |
| DI2.0858 | 504238203 | HEAD LAMP RH ELECTRIC CHROME H7/H7/W5W/ |
| DI2.0859 | 504238213 | HEAD LAMP LH ELECTRIC CHROME H7/H7/W5W/ |
| DC2.3544 | 5801572024 | FRONT CORNER LAMP RH P21W, WHITE |
| DC2.3545 | 5801594848 | FRONT CORNER LAMP LH P21W, WHITE |
| DC0.0856 | 500375431,504103304,2997119 | FOOTBOARD (BLACK), RH |
| DC0.0857 | 500375430,504103303,2997118 | FOOTBOARD (BLACK), LH |

| DIESSA REF. | O.E.M. REF. | DESCRIPTION |
|-------------|-----------------------|-----------------------------------------|
| DC2.2478 | 41298962 | HALF REAR FENDER FRONT PART |
| DC2.2891 | 5801550647 | RADIATOR FRONT GRILLE |
| DC2.2999CR | 504135530CR | RIGHT CHROME FOG COVER |
| DC2.3000CR | 504135532CR | LEFT FOG COVER CHROME |
| DC2.3749 | 5802055591,5802066514 | BUMPER |
| DC2.3480 | 5801546522 | IVECO STRALIS SUN VISOR MARKER LAMP LED |
| DC2.3481 | 5801546548 | IVECO STRALIS SUN VISOR MARKER LAMP DE |
| DC2.3008 | 504250999 | SIDE LAMP RH |
| DC2.3009 | 504250991 | SIDE LAMP LH |



DC2.3480



DC2.3481



DI2.0674



DC2.3545



DC2.3544



DI2.0675



D0500263



DC2.2999CR



DC2.2478



DC2.3000CR



D0500264



DI2.0670



DC0.0856



DI2.0668



DI2.0669



DC0.0857



DI2.0671

The parts referenced in this catalog are not original, but are perfectly adaptable to the models to which they are intended.
The use of the manufacturers' marks and the original references is done exclusively for the purpose of indicating the model to which each piece is destined.

IV AS STRALIS 2013 HI-WAY_EURO6



DC0.1576

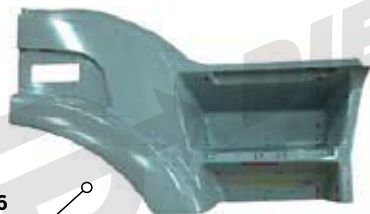

DC0.1577



D0700240



D0700241



DI0.0017



DI0.0016



DI2.0879



D0700279



DC2.2280CZ



DI2.0666



DC2.2998



DC2.2890



DC2.3855

DC2.3748CZ



DI2.0667



DC0.2033

DI2.0676



810 mm

560 mm

DI2.0090



DC0.2034



The parts referenced in this catalog are not original, but are perfectly adaptable to the models to which they are intended.
The use of the manufacturers' marks and the original references is done exclusively for the purpose of indicating the model to which each piece is destined.



The parts referenced in this catalog are not original, but are perfectly adaptable to the models to which they are intended.
 The use of the manufacturers' marks and the original references is done exclusively for the purpose of indicating the model to which each piece is destined.

IV AS STRALIS 2013 HI-WAY_EURO6

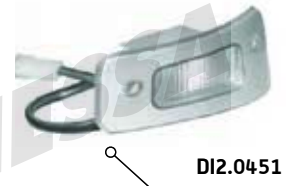
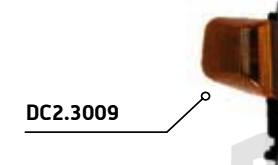
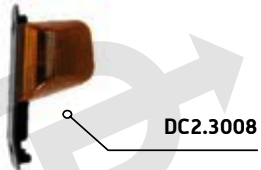

D0500582
D0500290
(manual)
DI2.0858
(electric chrome)



D0500583
D0500291
(manual)
DI2.0859
(electric chrome)



DC2.2220

DC2.2316



DI2.0863



The parts referenced in this catalog are not original, but are perfectly adaptable to the models to which they are intended. The use of the manufacturers' marks and the original references is done exclusively for the purpose of indicating the model to which each piece is destined.

| DIESSA REF. | O.E.M. REF. | DESCRIPTION |
|-------------|------------------------------------|-----------------------------------|
| DC2.2280CZ | 5801603578 | FR BUMPER (HI-WAY) PRIMED |
| DI2.0676 | 504194669 | UPPER STEP ON BUMPER |
| DI2.0090 | 504135514 | LOWER STEP ON BUMPER |
| DC0.2033 | 41213720 | CAP ON MUDGUARD RH |
| DC0.2034 | 41213721 | CAP ON MUDGUARD LH |
| DC2.2998 | 5801546918 | AIR DEFLECTOR RH |
| DC2.2890 | 5801552904 | AIR DEFLECTOR LH |
| DC2.2281 | 5801549064,0,5801546913 | FRONT GRILLE |
| DI0.0017 | 504008290 | COVER RH, SIDE BUMPER |
| DI0.0016 | 504194533,504008291 | COVER LH, SIDE BUMPER |
| DI2.0670 | 504187506 | BUMPER LID, RH |
| DI2.0671 | 504187507 | BUMPER LID, LH |
| DI2.0668 | 504187426 | BUMPER LID, RH |
| DI2.0669 | 504187427 | BUMPER LID, LH |
| DI2.0666 | 504187294 | BUMPER LID, RH |
| DI2.0667 | 504187339 | BUMPER LID, LH |
| DC2.2343 | 5801562137 | CENTRAL LOWER BUMPER SPOILER |
| DC2.2282 | 5801562167 | LOWER BUMPER SPOILER RH |
| DC2.2283 | 5801562166 | LOWER BUMPER SPOILER LH |
| DC0.1576 | 504103308,500375667,5801840545 | FRONT FENDER W/ HOLE, RH (AS) |
| DC0.1577 | 504103305,500375472,504081139 | FRONT FENDER W/ HOLE, LH (AS) |
| DI2.0846 | 504181096; 50418109600 | HIGH BEAM LAMP (INNER) RH=LH H1 |
| DI2.0788 | 504181095 | FOG LAMP, RH=LH H1 |
| D0500582 | 504020189,41221015 | HEAD LAMP ELEC/MAN, RH H7/H7/W5W/ |
| D0500583 | 504020193,41221036 | HEAD LAMP ELEC/MAN, LH H7/H7/W5W/ |
| DC2.3035 | 5801639118, 5801745781, 5801745449 | HEAD LAMP ELEC/MAN, LH H7/H7/LED |
| DC2.3288 | 5801639122, 5801745452 | HEAD LAMP ELEC/MAN, RH H7/H7/LED |
| DI2.0030 | 500314717 | SUN VISOR'S MARKER RH BLACK |
| DI2.0031 | 500314716 | SUN VISOR'S MARKER LH BLACK |
| DI2.0452 | 98461649 | SUN VISOR'S MARKER RH SILVER |
| DI2.0451 | 98461648 | SUN VISOR'S MARKER LH SILVER |

| DIESSA REF. | O.E.M. REF. | DESCRIPTION |
|-------------|-------------------------------|--------------------------------------------------------------------|
| DI2.0864 | 41221029,504250984,504098245 | SIDE LAMP RH P21W |
| D0500330 | 41221029,504250958 | SIDE LAMP LH P21W |
| DC2.2220 | 5801572074,5801754885 | SIDE LAMP RH 3 HOLES P21W |
| DC2.2316 | 5801572080,5801754886 | SIDE LAMP LH 3 HOLES P21W |
| DI0.0004 | 42555041,504187906,0 | FRONT CORNER LAMP RH P21W |
| DI0.0005 | 42555042,5801755124,504187902 | FRONT CORNER LAMP LH P21W |
| D0500478 | 99463242,504094705 | TAIL LAMP RH W/O LICENSE LAMP R5W/P21W/P21W/R5W/R5W/P21W/P21W/R10W |
| D0500477 | 99463244,99463243,504094715 | TAIL LAMP LH W/O LICENSE LAMP R5W/P21W/P21W/R5W/R5W/P21W/P21W/R10W |
| DI2.0672 | 504173478 | FOG LAMP HOUSING SUPPORT, RH |
| DI2.0673 | 50417347700; 504173477 | FOG LAMP HOUSING SUPPORT, LH |
| DI2.0674 | 504188129 | FOG LAMP HOUSING W/HOLE, RH |
| DI2.0675 | 504188130 | FOG LAMP HOUSING W/HOLE, LH |
| DI2.0776 | 504187939 | FOG LAMP HOUSING W/O HOLE, RH |
| DI2.0777 | 504187940 | FOG LAMP HOUSING W/O HOLE, LH |
| DC2.2886 | 5801584081 | FR/LAMP HSG W/HOLE, CHROME, RH |
| DC2.2887 | 5801584082 | FR/LAMP HSG W/HOLE, CHROME, LH |
| D0500359 | 99487780,2997195 | ELECTRICAL WINDOW REGULATOR RH W/O MOTOR |
| DC0.0995 | 99487781,2997196 | ELECTRICAL WINDOW REGULATOR RH W/O MOTOR |
| D0700240 | 8144393,98442028 | FOOTSTEP RH |
| D0700241 | 8144394,98442029 | FOOTSTEP LH |
| D0700070 | 41213750,41213691,41298975 | TOP MUDGUARD RH/LH |
| DI2.0857 | 41213751,41298976 | TOP MUDGUARD RH/LH FLAT TYPE |
| D0700285 | 41213754 | "REAR HALF MUDGUARD RH/LH LONG" |
| D0700279 | 41213696,2997670 | RUBBER STRAP |
| DC0.2038 | 41213729 | MUDGUARD SUPPORT LH |
| DC0.2037 | 41213731 | MUDGUARD SUPPORT RH |
| DC0.2036 | 41213725 | MUDGUARD SUPPORT LH |
| DC0.2035 | 41213727 | MUDGUARD SUPPORT RH |
| D0600174 | 98474429 | BATTERY COVER |

| DIESSA REF. | O.E.M. REF. | DESCRIPTION |
|-------------|------------------------------------------|-----------------------------------------------------------------------------------------------------------------------------------------------------|
| DI2.0862 | 504150552,504369995,5801341207 | COMPLETE MIRROR RH CLASS II+ CLASS IV, MAIN MIRROR H ELECTRIC CLASS II, WIDE ANGLE MIRROR ELECTRIC CLASS IV, HEATED BLACK LONG ARM, R1200 +R300 LHD |
| DI2.0861 | 504150551,504369979,5801341206 | COMPLETE MIRROR LH CLASS II+ CLASS IV, MAIN MIRROR H ELECTRIC CLASS II, WIDE ANGLE MIRROR ELECTRIC CLASS IV, HEATED BLACK LONG ARM, R1200 +R300 LHD |
| DI2.0061 | 504150526,504369910,5801334614 | COMPLETE MIRROR LH CLASS II+ CLASS IV, MAIN MIRROR ELECTRIC CLASS II, WIDE ANGLE MIRROR ELECTRIC CLASS IV, HEATED BLACK SHORT ARM, R1200 +R300 LHD |
| DI2.0062 | 504150527,504369961,5801334610 | COMPLETE MIRROR RH CLASS II+ CLASS IV, MAIN MIRROR ELECTRIC CLASS II, WIDE ANGLE MIRROR ELECTRIC CLASS IV, HEATED BLACK SHORT ARM, R1200 +R300 LHD |
| DI2.0871 | 504150538,504370048,5801336285 | COMPLETE MIRROR LH CLASS II+ CLASS IV, MAIN MIRROR ELECTRIC CLASS II, WIDE ANGLE MIRROR ELECTRIC CLASS IV, HEATED BLACK MEDIUM ARM, R1200 +R300 LHD |
| DI2.0872 | 504150539,504370055,5801336298 | COMPLETE MIRROR RH CLASS II+ CLASS IV, MAIN MIRROR ELECTRIC CLASS II, WIDE ANGLE MIRROR ELECTRIC CLASS IV, HEATED BLACK MEDIUM ARM, R1200 +R300 LHD |
| DI2.0055 | 504197879,2997668 | MIRROR GLASS CLASS IV WIDE ANGLE RH=LH HEATED R300 LHD |
| DI2.0054 | 504197878,504159282,504159284 | MIRROR GLASS CLASS II RH=LH HEATED R1200 LHD |
| DI2.0809 | 504168236 | MIRROR ROOF CLASS V RH MANUAL HEATED R300 LHD |
| DI2.0810 | 504224428 | FRONT MIRROR CLASS VI RH MANUAL HEATED R300 LHD |
| D0500290 | 504020189 | HEAD LAMP RH MANUAL H7/H7/W5W/ |
| D0500291 | 504020193 | HEAD LAMP LH MANUAL H7/H7/W5W/ |
| DI2.0858 | 504238203 | HEAD LAMP RH ELECTRIC CHROME H7/H7/W5W/ |
| DI2.0859 | 504238213 | HEAD LAMP LH ELECTRIC CHROME H7/H7/W5W/ |
| DC2.2478 | 41298962 | HALF REAR FENDER FRONT PART |
| D0500263 | 504029044, 504044980, 504211611 | DOOR EXTENSION RH |
| D0500264 | 504029045, 504044981, 504211612 | DOOR EXTENSION LH |
| DC0.0856 | 2997119, 500375431, 504103304 | FOOTBOARD (BLACK), RH |
| DC0.0857 | 2997118, 500375430, 504103303, 504368376 | FOOTBOARD (BLACK), LH |
| DC2.2999CR | 504135530CR | LEFT CHROME FOG COVER |
| DC2.3000CR | 504135532CR | RIGHT CHROME FOG COVER |
| DC2.3748CZ | 5802055590, 5802067261 | BUMPER |
| DI2.0879 | 504186928, 504287143 | RADIATOR FRONT GRILLE BUMPER |
| DC2.3008 | 504250999 | SIDE LAMP RH |
| DC2.3009 | 504250991 | SIDE LAMP LH |

| DIESSA REF. | O.E.M. REF. | DESCRIPTION |
|-------------|-------------|-----------------------------------------|
| DC2.3480 | 5801546522 | IVECO STRALIS SUN VISOR MARKER LAMP LED |
| DC2.3481 | 5801546548 | IVECO STRALIS SUN VISOR MARKER LAMP LED |
| DC2.3544 | 5801572024 | FRONT COVER LAMP LH P.21W WHITE |
| DC2.3545 | 5801572018 | FRONT COVER LAMP RH P.21W WHITE |
| DC2.3854 | 5801603597 | FRONT BUMPER WITH BLACK TIPS |
| DC2.3855 | 5801974516 | BUMPER COVER HOLLOW CAMERA |



D0600244



D0600245



DC2.3511



DI2.0846



DC2.3756



DC2.3288



DC2.3035



DI2.0788



DC2.3754



DI2.0858



DI2.0859



DC2.3750



DC2.3751



DC2.3752



DC2.3753



DC2.3755

Las piezas referenciadas en este catálogo no son originales, pero son perfectamente adaptables a los modelos a los que van destinadas. El uso de las marcas de fabricantes y de las referencias originales se hace exclusivamente con el propósito de indicar el modelo al que va destinada cada pieza.



DC2.3757



DC2.3856



DC2.3857



DC2.3858



DC2.3864



DC2.3862



DC2.3863



DC2.3865



DC2.3859



DC2.3860



DC2.3866



DC2.3517



DC2.3516



DC2.3867



DC2.3861

Las piezas referenciadas en este catálogo no son originales, pero son perfectamente adaptables a los modelos a los que van destinadas.
El uso de las marcas de fabricantes y de las referencias originales se hace exclusivamente con el propósito de indicar el modelo al que va destinada cada pieza.

| DIESSA REF. | O.E.M. REF. | DESCRIPTION |
|-------------|------------------------------------|-----------------------------------------|
| D0600244 | 504037735, 504058445 | FOOTSTEP MUDGUARD RH |
| D0600245 | 504037737, 504058446, 504299045 | FOOTSTEP MUDGUARD LH |
| DC2.3511 | 5801696201 | FRONT BUMPER |
| DC2.3754 | 5801690586 | FRONT BUMPER |
| DC2.3755 | 5801690552 | FRONT BUMPER |
| DC2.3756 | 5801690553 | FRONT BUMPER |
| DC2.3288 | 5801639122, 5801745452 | HEAD LAMP ELEC/MAN, RH H7/H7/LED |
| DC2.3035 | 5801639118, 5801745781, 5801745449 | HEAD LAMP ELEC/MAN, LH H7/H7/LED |
| DI2.0858 | 504238203 | HEAD LAMP RH ELECTRIC CHROME H7/H7/W5W/ |
| DI2.0859 | 504238213 | HEAD LAMP LH ELECTRIC CHROME H7/H7/W5W/ |
| DI2.0788 | 504181095 | FOG LAMP, RH=LH H1 |
| DI2.0846 | 50418109600, 504181096 | HIGH BEAM LAMP (INNER) RH=LH H1 |
| DC2.3752 | 5801690583 | FRONT BUMPER |
| DC2.3753 | 5801690585 | FRONT BUMPER |
| DC2.3750 | 5801690588 | FRONT BUMPER |
| DC2.3751 | 5801690590 | FRONT BUMPER |
| DC2.3757 | 5801938050 | BUMPER CAM COVER |
| DC2.3856 | 5801692865 | BUMPER CAP, RH |
| DC2.3857 | 5801692867 | BUMPER CAP, LH |
| DC2.3858 | 5801692850 | BUMPER CAP, RH |
| DC2.3859 | 5801692854 | BUMPER CAP, LH |
| DC2.3860 | 5801692828 | BUMPER CAP, RH |
| DC2.3861 | 5801692841 | BUMPER CAP, LH |
| DC2.3862 | 5801693487 | BUMPER CAP, RH |
| DC2.3863 | 5801693491 | BUMPER CAP, LH |
| DC2.3864 | 5801693456 | BUMPER CAP, RH |
| DC2.3865 | 5801693457 | BUMPER CAP, LH |
| DC2.3866 | 5801693540 | BUMPER CAP, RH |
| DC2.3867 | 5801693556 | BUMPER CAP, LH |
| DC2.3757 | 5801938050 | BUMPER CAM COVER |
| DC2.3516 | 1837854, 2006328 | DEFLECTOR DE AIRE IZD |
| DC2.3517 | 5801690102 | DEFLECTOR DE AIRE DCH |



Calle de la Ciruela 3
Polígono Industrial El Carralero II
C.Postal E28222 - Majadahonda
Madrid - España
916 347 655
info@diessa.es

www.diessa.es